

Godox

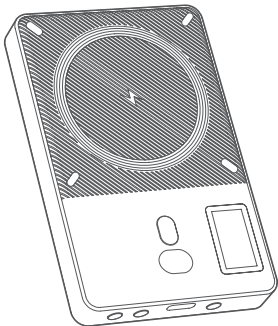

MA5R

神牛磁吸充电全彩补光灯

Godox Magnetic Charging Full Color LED Light

使用手册

Instruction Manual

V1.0

重要安全提示

首先作为最基本原则：本产品为专业灯光布景设备，应由专业灯光师使用或在专业人士指导下使用。使用时必须始终遵循基本的安全预防措施，具体安全预防措施如下：

- 使用前必须阅读并理解产品说明书。
- 专业灯具，禁止儿童使用。当儿童靠近时，家长或监护人必须密切监督，以免儿童因碰撞灯具或私用灯具造成人身伤害。
- 本灯具并非普通照明灯具，不可用于普通照明，任何有过眼部损伤或眼部敏感的人群均应避免使用本灯具。
- 灯具点亮时，必须小心使用，禁止接触高温部件，如LED灯珠，以免造成灼伤。
- 灯具点亮时，任何情况下均禁止直视灯珠。应该在专业灯光师指导下使用强光，任何情况下避免长时间处于强光环境，如引起眼睛不适，请及时关闭灯具，暂停使用，请及时就医。
- 若灯珠损坏或因热变形，应停止使用，并及时联系制造商、服务代理商或合格的维修人员更换灯珠，以免发生意外。
- 请勿使用损坏的设备或设备配件，待专业维修人员检查维修，确认设备正常方可使用。
- 在使用过程中，如果本产品由于跌落、受到挤压或遭受强烈冲击而造成外壳破裂的，请勿继续使用，以免因接触到内部电子元件而受到电击伤害。
- 在清洁和维修之前，请务必从电源插座上拔下该设备

插头。不使用时，禁止拉扯电源线以将设备插头从电源插座中拔出。

- 本设备没有防水性能，请让设备保持干燥，请勿将本设备浸入水中或其他液体中。设备需安装在干燥且通风处，避免在雨天、潮湿、多尘或过热环境下使用。请勿将任何物体置于灯具上或使液体流入灯具内部，以免发生意外。
- 请勿私自拆卸产品，如产品出现故障，须由本公司或授权的维修人员进行检查维修。
- 存放本设备之前，请确保设备已完全冷却。存放时，将电源线从设备上拔出。设备应放置于设备便携包内或通风干燥处。
- 请勿将设备放置在酒精、汽油等易燃易挥发的溶剂附近。
- 本厂不推荐的产品附件，请勿使用，以免导致火灾、触电或人身伤害。
- 本产品已通过 ROHS, CE 和 FCC 认证，请参考相关国家标准使用和操作。
- 安全说明依据本厂严格测试制定，设备设计和规格如有变更，恕不另行通知。客户可以上神牛官网查看最新的电子版说明，了解产品最新资讯。
- 部分产品内置锂电池，此类产品请使用专用的充电器进行充电，并且按正确的操作说明，在规定的电压、温度范围内使用。
- 一年保修期，消耗品如电池、适配器、电源线等配件不在此保修范围内。
- 经发现，擅自检修设备，将取消一年保修期，维修需

要收取相关费用。

- 对于不规范操作引起的机器故障不在保修范围内。



请勿直视光源

前言

感谢您购买神牛产品！

神牛全新推出磁吸充电全彩补光灯 MA5R，亮度、色温、GM 值可调，14 类 FX 光效模式，提供磁吸充电宝功能，内置蓝牙及 NFC 功能，适用于户外手机直播、摄影、vlog 等场景下补光。

部件名称

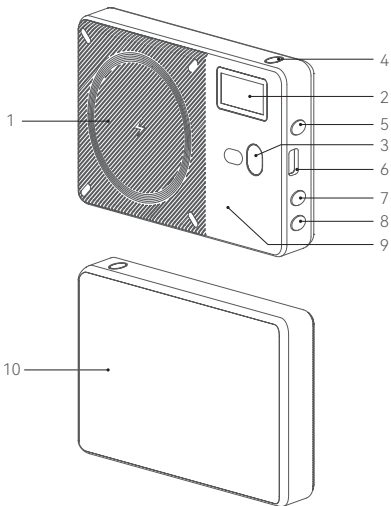

1. 磁吸充电区

2. 彩屏

3. 自拍灯

4. 开关按键

5. 确认 / 返回按键

6. USB-C 充电口

7. + 按键

8. - 按键

9. NFC 感应区

10. 补光灯

物品清单



灯体 *1



充电线 *1



硅胶柔光罩 *1



引磁环 *1



说明书 *1

引磁环使用方法

将手机或手机壳背部擦拭干净，撕下引磁片的背胶贴纸后将其粘贴在无线充电位置，再将蓝膜撕下即可正常磁吸使用（各品牌手机无线充电位置不一样，找准位置后再进行粘贴）。

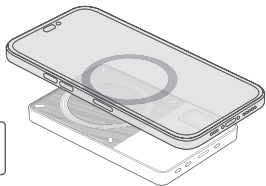

x





√



x

开关按键





功能①：关机状态下短按 ，屏幕仅出现电量提示，可为手机充电；再次短按 ，屏幕熄灭即关机完毕。

功能②：长按  实现开机，屏幕出现参数界面，可设置灯光参数；再次长按 ，屏幕熄灭即关机完毕。



注：亮灯时无法同时给手机进行充电。

确认 / 返回按键

长按  进入模式选择界面，短按  在 CCT/HSI/ 特效 / 自拍 / 菜单设置中依次选择，短按  回退选择，选中其中一项后短按  进入该项的具体设置，设置完毕长按  返回上一级。



模式设置

短按 \oplus 或 \ominus 选择参数组，选中其中一项后短按 $\frac{\text{☞}}{\text{☞}}$ 进入该组进行具体设置，此时 \oplus 和 \ominus 作为参数值增减按键，短按慢调，长按快调。



CCT 模式

亮度范围：0% ~ 100%
色温范围：1800K ~ 10000K
GM 范围：-50 ~ +50



HSI 模式

亮度范围：0% ~ 100%
色相范围：0° ~ 360°
饱和度范围：0% ~ 100%



特效模式



1. 闪光灯

此光效模拟闪光灯闪光或传统镁光灯闪光，常用于营造一种生动、活泼的氛围。

开关：开启 / 关闭

亮度：0% -100%

颜色：CCT/HSI

色温 / 色相：1800K-10000K/0-360°

速度：1-100

模式：闪光灯 / 镁光灯

触发：自动 / 手动

2. 雷闪电

此光效模拟雷电的闪电，常用于营造一种紧张、恐怖或神秘的氛围。

开关：开启 / 关闭

亮度：0% -100%

色温：1800K-10000K

闪烁次数：随机 /1-10

频率：随机 /2-20

触发：自动 / 手动

3. 多云

此光效模拟云层遮挡效果，常用于营造一种阴沉、压抑或悲伤氛围。

开关：开启 / 关闭

亮度：0% -100%

亮暗比例：30%-90%

速度：随机 /1-100

4. 坏灯泡

此光效模拟一盏损坏的灯泡闪光，常用于营造昏黄的环境氛围。

开关：开启 / 关闭

亮度：0% -100%

颜色：CCT/HSI

色温 / 色相：1800K-10000K/0-360°

速度：1-100

5. 电视机

此光效模拟电视机或屏幕的光线效果，常用于营造出一种冷淡、机械或数字化的氛围。

开关：开启 / 关闭

亮度：0% -100%

颜色：CCT/HSI

速度：1-100

6. 蜡烛

此光效模拟蜡烛的光线效果，常用于营造出一种柔和、温暖、闪烁的氛围。

开关：开启 / 关闭

亮度：0% -100%

速度：1-100

7. 火

此光效模拟火焰的光线效果，常用于营造出一种明亮、热烈、闪烁氛围。

开关：开启 / 关闭

亮度：0% -100%

速度：1-100

8. 烟花

此光效模拟烟花的光线效果，常用于营造出一种绚丽、多彩、浪漫的氛围。

开关：开启 / 关闭

亮度：0% -100%

余烬：1-100

速度：1-100

9. 爆炸

此光效模拟爆炸的光线效果，常用于营造出一种明亮、猛烈、闪烁氛围。

开关：开启 / 关闭

亮度：0% -100%

颜色：CCT/HSI

色温 / 色相：1800K-10000K/0-360°

余烬：1-100

速度：1-100

触发：自动 / 手动

10. 焊接

此光效模拟焊接的光线效果，常用于营造出一种炽热、机械的氛围。

开关：开启 / 关闭

亮度：0% -100%

颜色：CCT/HSI

色温 / 色相：1800K-10000K/0-360°

速度：1-100

11. 警车

此光效模拟警车灯光的闪烁效果，常用于营造紧张、追逐或紧张氛围。

开关：开启 / 关闭

亮度：0% -100%

颜色：红 + 蓝、红、蓝、蓝 + 白、蓝 + 黄、黄、红 + 蓝 + 白、红 + 黄 + 蓝

模式：1-5

12.SOS SOS

此光效模拟 SOS 求救信号的闪烁效果，常用于营造危险、求救或紧急情况氛围。

开关：开启 / 关闭

亮度：0% -100%

颜色：CCT/HSI

色温 / 色相：1800K-10000K/0-360°

13. 彩光循环

此光效模拟彩色光线的循环和变化效果，常用于营造一种梦幻、科幻的氛围。

开关：开启 / 关闭

亮度：0% -100%

饱和度：0%-100%

速度：1-100

14. 派对

此光效模拟彩色光线、闪光灯和激光等效果，常用于营造出一种狂欢、欢乐、高能氛围。

开关：开启 / 关闭

亮度：0% -100%

饱和度：0%-100%

速度：1-100

自拍模式

自拍模式可调节自拍灯的亮度和色温。

亮度：0% -100%

色温：2800K-6500K



菜单设置

进入菜单，短按 \oplus 或 \ominus 选择以下功能，选中其中一项后短按 $\frac{\infty}{\circ}$ 进入该功能进行具体设置，设置完毕长按 $\frac{\infty}{\circ}$ 返回上一级。



1. 蓝牙

选中蓝牙，短按 $\frac{\infty}{\circ}$ 进入，可设置开启 / 关闭 / 重置，下方蓝牙 MAC 码方便查找灯具。

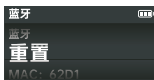

“Godox Light”app 下载

扫描二维码即可下载“Godox Light”手机 app（安卓和苹果系统都可以使用）。

注：

1. 首个移动设备（手机或平板电脑）可直接使用 app 操控灯体。更换其他移动设备时，灯体需进行蓝牙重置方可正常使用 app。

2. app 需升级至 V3.0 以上版本。



“Godox Light”app 固件升级

手机中打开 Godox Light，进入其中一个场景，点击 +（添加设备），设备添加完成后，点击 ⋮ 延伸出多项设置，再选择固件升级即可。



2. 语言

选中语言，短按  进入，可设置简体中文 /English。



3. 版本与升级

选中版本与升级，短按  进入，此界面查看升级提示。



4. 恢复出厂设置

选中恢复出厂设置，短按  进入，可设置取消 / 确定；确定恢复出厂后灯具重启，选择需要的语言后自动来到 CCT 模式。



5. 灯具信息

选中灯具信息，短按  进入，此界面查看如图示内容。



NFC 加灯

通过手机 NFC 功能与灯具 NFC 芯片相互通信后完成快速添加灯具到【Godox light】App 中。

- 1、前置条件：灯具支持 NFC 添加、【Godox light】App 版本 V3.2.4 以上、手机开启蓝牙和 NFC 功能。
- 2、使用方法：前置条件成立情况下，打开【Godox light】进入对应场景中，点击【+】选择【NFC 加灯】功能，进入【NFC 添加设备】页面将手机 NFC 感应区靠近灯具感应区即可完成加灯，支持多灯添加。

注意：Android 系统直接靠近感应加灯，iOS 需点击右上角  图标后出现弹窗感应加灯。

照度数据 (补光灯)

色温	测试条件	照度单位	0.3m	0.5m	1m
1800K	裸灯	lux	698	260	67
		fc	65	24	6
	搭配柔光罩	lux	367	139	37
		fc	34	13	3
2800K	裸灯	lux	1150	430	111
		fc	107	40	10
	搭配柔光罩	lux	608	231	60
		fc	57	22	6
3200K	裸灯	lux	1180	442	114
		fc	110	41	11
	搭配柔光罩	lux	624	237	62
		fc	58	22	6
4300K	裸灯	lux	1250	465	120
		fc	116	43	11
	搭配柔光罩	lux	656	250	65
		fc	61	23	6
5600K	裸灯	lux	1360	509	132
		fc	127	47	12
	搭配柔光罩	lux	717	272	70
		fc	67	25	7
6500K	裸灯	lux	1400	523	135
		fc	130	49	13
	搭配柔光罩	lux	736	279	72
		fc	68	26	7

色温	测试条件	照度单位	0.3m	0.5m	1m
8500K	裸灯	lux	1260	472	122
		fc	118	44	11
	搭配柔光罩	lux	661	251	65
		fc	62	23	6
10000K	裸灯	lux	1180	441	114
		fc	110	41	11
	搭配柔光罩	lux	619	235	61
		fc	58	22	6
R (红光)	裸灯	lux	483	178	46
		fc	45	17	4
	搭配柔光罩	lux	254	96	25
		fc	24	9	2
G (绿光)	裸灯	lux	1220	458	118
		fc	114	43	11
	搭配柔光罩	lux	634	241	62
		fc	59	22	6
B (蓝光)	裸灯	lux	242	90	24
		fc	23	8	2
	搭配柔光罩	lux	139	53	14
		fc	13	5	1

以上数据均为平均值，非绝对值，以上测试皆在灯体 100%亮度下进行。

照度数据（自拍灯）

色温	测试条件	照度单位	0.3m	0.5m
2800K	裸灯	lux	44	17
		fc	4	2
3200K		lux	45	17
		fc	4	2
4300K		lux	46	17
		fc	4	2
5600K		lux	51	19
		fc	5	2
6500K	lux	54	20	
	fc	5	2	

以上数据均为平均值，非绝对值，以上测试皆在灯体 100%亮度下进行。

规格参数

型号	MA5R
锂电池	3.7V 4900mAh 18.13Wh
功率	补光灯: 5W
	自拍灯: 0.8W
USB-C 充电口	输入: 5V = 3A, 9V = 2.22A, 12V = 1.67A, 18W (Max.)
	输出: 5V = 3A, 9V = 2.22A, 12V = 1.67A
充电时长	≈ 1 小时 30 分钟
使用时长	≈ 3 小时 40 分钟 (100% 亮度输出)
	≈ 7 小时 20 分钟 (50% 亮度输出)
色温	补光灯: 1800K-10000K
	自拍灯: 2800K-6500K
GM 调节	-50 ~ +50
调光范围	0% ~ 100%
FX 光效	14 类
CRI	补光灯: 平均≥ 95, 自拍灯: 平均≥ 96
TLCI	补光灯: 平均≥ 97, 自拍灯: 平均≥ 98
控制方式	蓝牙 app 控制 / 灯体控制
蓝牙控制距离	30m
工作环境温度	-10°C ~ 40°C
尺寸	≈ 107mm*68mm*13mm
净重	≈ 164g

规格和参数如有变更, 恕不另行通知。

Safety Instructions and Attentions

First of all, as the most basic principle: This product is a professional lighting set equipment and should be used by professional lighting engineers or under the guidance of professionals. Basic safety attentions must always be followed during use, as follows:

- Before use, please read and understand these instructions and attentions.
- Professional lighting is prohibited for children. When children are near, parents or accompanying persons must supervise closely to prevent children from personal injury due to collision with lamps or private use of lamps.
- This lighting product is not ordinary lighting product and cannot be used for general lighting. Anyone who has suffered eye damage or has sensitive eyes should avoid using this product.
- When the lamp is on, it must be used with care. Do not touch high-temperature parts, such as LED lamp beads, to avoid burns.
- When the lamp is on, it is forbidden to look directly at the lamp beads under any circumstances. Strong light should be used under the guidance of professional lighting engineers. Avoid prolonged exposure to strong light under any circumstances. If eye discomfort, please turn off the lamp in time, suspend use, and see a doctor immediately.
- If the lamp bead is damaged or deformed by heat, stop using this equipment, and contact the manufacturer, service agent or qualified maintenance personnel to replace the lamp bead in time to avoid accidents.
- Do not use damaged equipment or accessories, and wait

for professional maintenance personnel to check and repair to confirm being normal before use.

- During using, if the casing of this product is broken due to being dropped, squeezed or subjected to strong impact, please do not use it, so as to avoid electric shock injury due to contact with internal electronic components.
- Be sure to unplug equipment from the power outlet before cleaning and repairing. When not in use, do not pull the power cord to unplug the equipment.
- This equipment is not waterproof, please keep it dry and do not immerse it in water or other liquids. The equipment should be installed in a dry and ventilated place, and avoid using it in rainy, humid, dusty or overheated environments. Do not place any objects on the lamp or let liquid flow into the lamp to avoid accidents.
- Do not disassemble the product without permission. If the product fails, it must be checked and repaired by authorized maintenance personnel.
- Before storing, make sure that the equipment has cooled down completely. For storage, unplug the power cord from the equipment. The equipment should be placed in the carrying case or in a ventilated dry place.
- Do not place equipment near flammable and volatile solvents such as alcohol and gasoline.
- Do not use accessories that are not recommended by our factory to avoid fire, electric shock or personal injury.
- This product complies with ROHS, CE and FCC certification, please refer to the relevant national standards for use and operation.

- The safety instructions are formulated according to the strict testing of the factory, and the design and specifications of the equipment are subject to change without prior notice. For latest product information, please check the GODOX website and view latest electronic instruction.
- Some products have built-in lithium batteries. Please use specified chargers, and use them within a proper range of the specified voltage and temperature according to the correct operating instructions.
- One-year warranty period, accessories such as consumable batteries, adapters, power cords, etc. are not covered by this warranty.
- If it is found that the equipment is repaired without authorization, the one-year warranty period will be cancelled and relevant fees will be charged for maintenance.
- Machine failures caused by non-standard operation are not covered by the warranty.



Do not stare at the operating light source.

Foreword

Thank you for purchasing!

Godox's newly launched magnetic charging full color LED light MA5R has adjustable brightness, CCT and GM value, 14 types of FX modes, magnetic charging function, built-in Bluetooth and NFC functions, quite suitable for outdoor mobile phone live broadcasting, photography, vlogging and other scenarios.

Name of Parts

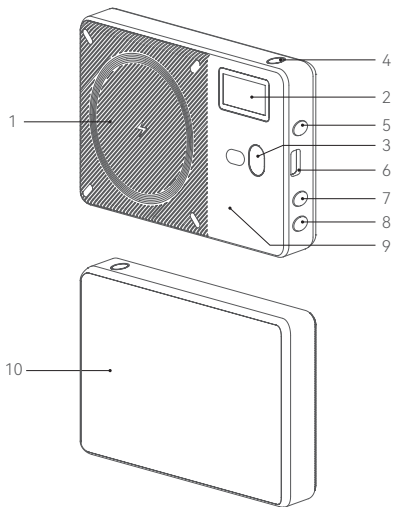

1. Magnetic Charging Area

2. Colorful Display

3. Selfie Lamp

4. Power Switch Button

5. Confirm/Return Button

6. USB-C Charging Port

7. + Button

8. - Button

9. NFC Sensing Area

10. Filling Lamp

What's Inside



Light Body
*1



Charging Cable
*1



Collapsible Diffusion
Dome *1



Magnetic Ring
*1





Instruction
Manual *1

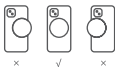
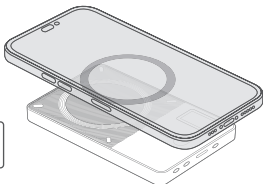

Using Instructions for Magnetic Ring

Wipe the back of the phone or phone case clean, remove the adhesive sticker of the magnetic ring and paste it in the wireless charging position, then tear off the blue film to use it (Wireless charging position of each brand of phone is different, find the right position and then paste).



Power Switch Button





Function ① : Short press the power switch button  in power off status, the screen only displays battery level, then it can charge the smartphone. Press the power switch button  again, the screen blacks out indicate it's turned off.

Function ② : Long press the power switch button  in power off status to turn the device on, the screen will display parameters. Long press the power switch button  again, the screen blacks out indicate it's turned off.

Note: It is not possible to charge the phone when the light is on.



Confirm/Return Button

Short press the confirm/return button  to enter mode selection interface, short press the  and  button to select among CCT mode, HIS, mode FX, selfie mode and menu, then press the confirm/return button  to enter the settings interface, long press it to return to the previous interface.



Mode Settings

Short press the \oplus or \ominus button to select the desired mode, short press the $\frac{\%}{\text{G}}$ button to enter the parameters interface. Press the \oplus button can increase the parameter value, while press the \ominus button can decrease the parameter value. Slow adjustment by short pressing, while quick adjustment by long pressing.



CCT Mode

DIM range: 0% ~ 100%
CCT range: 1800K ~ 10000K
GM range: -50 ~ +50



HSI Mode

DIM range: 0% ~ 100%
HUE range: 0° ~ 360°
SAT range: 0% ~ 100%



FX Mode



1. Flash

This light effect simulates the flash of a camera flash or a traditional flash bulb, often used to create a lively and dynamic atmosphere.

Switch: Turn on/off the effect

DIM: 0% ~ 100%

Color: CCT/HSI

CCT/HUE: 1800K-10000K/0-360°

Speed: 1-100

Mode: Camera Flash/Flash Bulb

Trigger: Auto/Manual

2. Lightning

This effect simulates the natural thunder and lightning and is often used to create a tense, terrifying or mysterious atmosphere.

Switch: Turn on/off the effect

DIM: 0% ~ 100%

CCT: 1800K-10000K

Times: Random/1-10

Frequency: Random /2-20

Trigger: Auto/Manual

3. Cloudy

This effect simulates the effect of cloud occlusion and is often used to create a gloomy, oppressive or sad atmosphere.

Switch: Turn on/off the effect

DIM: 0% ~ 100%

Ratio: 30% -90%

Speed: Random/1-100

4. Broken Bulb

This effect simulates the effect of a broken bulb and is often used to create a dim atmosphere.

Switch: Turn on/off the effect

DIM: 0% ~ 100%

Color: CCT/HSI

CCT/HUE: 1800K-10000K/0-360°

Speed: 1-100

5. TV

This effect simulates the effect of light from a television or screen and is often used to create a cold, mechanical or digital atmosphere.

Switch: Turn on/off the effect

DIM: 0% ~ 100%

Color: CCT/HSI

Speed: 1-100

6. Candle

This effect simulates the effect of light from a candle and is often used to create a soft, warm, shimmering atmosphere.

Switch: Turn on/off the effect

DIM: 0% ~ 100%

Speed: 1-100

7. Fire

This effect simulates the effect of light from flame and is often used to create a bright, warm, shimmering atmosphere.

Switch: Turn on/off the effect

DIM: 0% ~ 100%

Speed: 1-100

8. Firework

This effect simulates the effect of light from fireworks and is often used to create a gorgeous, colorful, romantic atmosphere.

Switch: Turn on/off the effect

DIM: 0% ~ 100%

Ember: 1-100

Speed: 1-100

9. Explosion

This effect simulates the effect of light from explosion and is often used to create a bright, fierce, shimmering atmosphere.

Switch: Turn on/off the effect

DIM: 0% ~ 100%

Color: CCT/HSI

CCT/HUE: 1800K-10000K/0-360°

Ember: 1-100

Speed: 1-100

Trigger: Auto/Manual

10. Welding

This effect simulates the effect of light from welding and is often used to create a hot, mechanical atmosphere.

Switch: Turn on/off the effect

DIM: 0% ~ 100%

Color: CCT/HSI

CCT/HUE: 1800K-10000K/0-360°

Speed: 1-100

11. Cop Car

This effect simulates the effect of light from cop car and is often used to create a tension, chasing atmosphere.

Switch: Turn on/off the effect

DIM: 0% ~ 100%

Color: Red+Blue, Red, Blue,
Blue+White, Blue+Yellow, Yellow,
Red+ Blue+White, Red+Yellow+Blue

Mode: 1-5

12. SOS SOS

This effect simulates the flashing effect of an SOS signal and is often used to create a dangerous, distress or emergency atmosphere.

Switch: Turn on/off the effect

DIM: 0% ~ 100%

Color: CCT/HSI

CCT/HUE: 1800K-10000K/0-360°

13. RGB Cycle

This effect simulates the effect cycle and change of colorful lights and is often used to create a fantasy, sci-fi atmosphere.

Switch: Turn on/off the effect

DIM: 0% ~ 100%

SAT: 0%-100%

Speed: 1-100

14. Party

This effect simulates the effect of colorful lights, flashes and laser, and is often used to create a carnival, fun, high energetic atmosphere.

Switch: Turn on/off the effect

DIM: 0% ~ 100%

SAT: 0%-100%

Speed: 1-100

Selfie Mode

The brightness and CCT of selfie lamp are adjustable in selfie mode.

DIM: 0% ~ 100%

CCT: 2800K-6500K



Menu Settings

Short press the \oplus or \ominus button to select among the following options, short press the \mathcal{R} button to enter the corresponding parameters interface, then long press the confirm/return button \mathcal{R} to return to the previous interface.



1. Bluetooth

Short press the \mathcal{R} button to enter the Bluetooth interface, in which you can turn on, turn off or reset the Bluetooth. The MAC code is on the corner for quick check.

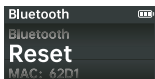

"GODOX Light" app Downloading

Scan the QR code to download the "Godox Light" smartphone app (can be used in Android and iOS).

Note:

1. The app can be used directly on the firstly installed device (smartphone or tablet). When change to other mobile device (smartphone or tablet), the light shall be reset before the normal connection of the app.
2. The app should be version 3.0 or above.



“GODOX Light” app Firmware Upgrade

Open Godox Light, enter a certain scene and click “+” to add a fixture, then click  to display more settings, choose firmware upgrade.

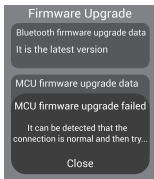

2. Language

Short press the  button to enter the language interface, in which you can choose between simplified Chinese and English.



3. Upgrade

Short press the  button to enter the upgrade interface, in which you can check the upgrade instruction.

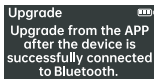

4. Factory Reset

Short press the  button to enter the factory reset interface, in which you can choose yes or no. If you choose yes, the device will automatically reset and reboot, then simplified Chinese and English options show on the display for your choice, after which it will turn to CCT mode automatically.



5. Fixture Info

Short press the  button to enter the fixture info interface, in which you can check the following information.



NFC Addition

Use the NFC function of smartphone and NFC chip of the light fixture to connect them, then add the light fixture to **【Godox Light】** app.

1. Preconditions: light fixture supports NFC addition, **【Godox Light】** app is V3.2.4 or above, Bluetooth and NFC functions of smartphone are turned on.

2. Operation Instructions: subject to the fulfillment of preconditions, turn on the **【Godox Light】** app and enter the corresponding scene, click **【+】** to select **【NFC Addition】** function, bring the NFC sensing area of smartphone near the sensing area of light fixture to scan to add in **【NFC Addition】** interface, bulk addition is also supported.

Note: Android systems can complete the addition by directly closing the sensing area, while iOS system need to click the  icon on the right top and wait for the pop-up window then add.

Illuminance Data (Filling Lamp)

CCT	Testing Condition	Unit	0.3m	0.5m	1m
1800K	Bare Light	lux	698	260	67
		fc	65	24	6
	With Diffusion Dome	lux	367	139	37
		fc	34	13	3
2800K	Bare Light	lux	1150	430	111
		fc	107	40	10
	With Diffusion Dome	lux	608	231	60
		fc	57	22	6
3200K	Bare Light	lux	1180	442	114
		fc	110	41	11
	With Diffusion Dome	lux	624	237	62
		fc	58	22	6
4300K	Bare Light	lux	1250	465	120
		fc	116	43	11
	With Diffusion Dome	lux	656	250	65
		fc	61	23	6
5600K	Bare Light	lux	1360	509	132
		fc	127	47	12
	With Diffusion Dome	lux	717	272	70
		fc	67	25	7
6500K	Bare Light	lux	1400	523	135
		fc	130	49	13
	With Diffusion Dome	lux	736	279	72
		fc	68	26	7

CCT	Testing Condition	Unit	0.3m	0.5m	1m
8500K	Bare Light	lux	1260	472	122
		fc	118	44	11
	With Diffusion Dome	lux	661	251	65
		fc	62	23	6
10000K	Bare Light	lux	1180	441	114
		fc	110	41	11
	With Diffusion Dome	lux	619	235	61
		fc	58	22	6
R (Red)	Bare Light	lux	483	178	46
		fc	45	17	4
	With Diffusion Dome	lux	254	96	25
		fc	24	9	2
G (Green)	Bare Light	lux	1220	458	118
		fc	114	43	11
	With Diffusion Dome	lux	634	241	62
		fc	59	22	6
B (Blue)	Bare Light	lux	242	90	24
		fc	23	8	2
	With Diffusion Dome	lux	139	53	14
		fc	13	5	1

Note: All the data are average values instead of absolute values. All the above tests are based on the condition of 100% brightness.

Illuminance Data (Selfie Lamp)

CCT	Testing Condition	Unit	0.3m	0.5m
2800K	Bare Light	lux	44	17
		fc	4	2
3200K		lux	45	17
		fc	4	2
4300K		lux	46	17
		fc	4	2
5600K		lux	51	19
		fc	5	2
6500K		lux	54	20
		fc	5	2

Note: All the data are average values instead of absolute values. All the above tests are based on the condition of 100% brightness.

Technical Data

Model	MA5R
Lithium Battery Parameters	3.7V 4900mAh 18.13Wh
Power	Filling lamp: 5W
	Selfie lamp: 0.8W
USB-C Charging Port	Input: 5V \Rightarrow 3A, 9V \Rightarrow 2.22A, 12V \Rightarrow 1.67A, 18W (Max.)
	Output: 5V \Rightarrow 3A, 9V \Rightarrow 2.22A, 12V \Rightarrow 1.67A
Charging Time	\approx 1h 30min
Working Time	\approx 3h 40min (100% brightness output)
	\approx 7h 20min (50% brightness output)
CCT	Filling lamp: 1800K-10000K
	Selfie lamp: 2800K-6500K
GM Adjust	-50 ~ +50
Brightness Range	0% ~ 100%
FX Modes	14
CRI	Filling lamp: average \geq 95
	Selfie lamp: average \geq 96
TLCI	Filling lamp: average \geq 97
	Selfie lamp: average \geq 98
Controlling Methods	Bluetooth app/Light Body Control
Bluetooth Controlling Distance	30m
Working Environment Temperature	-10°C ~ 40°C
Dimension	\approx 4.21"*2.68"*0.51"
Netweight	\approx 164g

Specifications and data may subject to changes without notice.

FCC Statement

This device complies with part 15 of the FCC Rules.

Operation is subject to the following two conditions:

- (1) This device may not cause harmful interference, and
- (2) this device must accept any interference received, including interference that may cause undesired operation.

Any Changes or modifications not expressly approved by the party responsible for compliance could void the user's authority to operate the equipment.

Note: This equipment has been tested and found to comply with the limits for a Class B digital device, pursuant to part 15 of the FCC Rules. These limits are designed to provide reasonable protection against harmful interference in a residential installation.

This equipment generates uses and can radiate radio frequency energy and, if not installed and used in accordance with the instructions, may cause harmful interference to radio communications. However, there is no guarantee that interference will not occur in a particular installation. If this equipment does cause harmful interference to radio or television reception, which can be determined by turning the equipment off and on, the user is encouraged to try to correct the interference by one or more of the following measures:

- Reorient or relocate the receiving antenna.
- Increase the separation between the equipment and receiver.
- Connect the equipment into an outlet on a circuit different from that to which the receiver is connected.
- Consult the dealer or an experienced radio/TV technician for help.

The device has been evaluated to meet general RF exposure requirement. The device can be used in portable exposure condition without restriction.

Warning

Operating frequency:2402MHz – 2480MHz (BT)

Maximum EIRP Power: 5dBm

Declaration of Conformity

GODOX Photo Equipment Co.,Ltd. hereby declares that this equipment are in compliance with the essential requirements and other relevant provisions of Directive 2014/53/EU. In accordance with Article 10(2) and Article 10(10), this product is allowed to be used in all EU member states.For more information of DoC, Please click this web link:

<https://www.godox.com/eu-declaration-of-conformity/>

The device complies with RF specifications when the device used at 0mm from your body.

产品保修

尊敬的用户，本保修卡是申请保修服务的重要凭证，请您配合销售商填写并妥善保管，谢谢！

产品信息	型号	产品条码
用户信息	姓名	联系电话
	通信地址	
销售商信息	名称	
	联系电话	
	通信地址	
	销售日期	
备注		

注：此表应由销售商盖章确认。

产品信息

本文件适用于相关《产品保修信息》(见后面说明)所列产品，其他非属此范围的产品或部件(如促销品、赠品及其他出厂后附加的部件等)不在此保修承诺内。

保修期

产品及部件的相应保修期按相关的《产品保修信息》执行。保修期自产品首次购买日起算，购买日以购买产品时保修卡登记日期为准。

如何获得保修服务

您可直接与产品销售商或授权服务机构联系，也可拨打神牛产品售后服务电话，与我们联系，由我们的服务人员为您安排服务。申请保修时，您应提供有效的保修卡作为保修凭证，方可获得保修。如您不能提供有效的保修卡，则在我们确认产品或部件属于保修范围的情况下，也可以为您提供保修，但这不作为我们的义务。

不适用保修情况

如产品存在下列情况，本文件项下的保证和服务将不适用：

- ①产品或部件超过相应保修期；
- ②错误或不当使用、维护或保管导致的故障或损坏，如：不当搬运；非按产品合理预期用途使用；不当插拔外接设备；跌落或外力挤压；接触或暴露于不适当温度、溶剂、酸碱、水浸或潮湿环境；
- ③由非神牛授权机构或人员安装、修理、更改、添加或拆卸造成的故障或损坏；
- ④产品或部件原有识别信息被修改变更或删除；
- ⑤无有效保修卡；
- ⑥使用非合法授权、非标准或非公开发行的软件造成的故障或损坏；
- ⑦因不可抗力或意外事件造成的故障或损坏；
- ⑧其他非因产品本身质量问题导致的故障或损坏。

遇上述情况，您应向相关责任方寻求解决，神牛对此不承担任何责任。因非在保修期或保修范围内的部件、附件或软件导致产品不能正常使用的，不是保修范围内的故障。产品使用过程中正常的脱色，磨损和消耗，不是保修范围内的故障。

产品保修和服务支持信息

产品的保修期和服务类型按以下《产品保修信息》执行：

产品类别	选件名称	保修期（月）	保修服务类型
部件	电路板	12	客户送修
其他	如外壳、保护罩、锁紧装置、包装等。	无	无保修

神牛产品售后服务电话 0755-29609320-8062

Warranty

Dear customers, as this warranty card is an important certificate to apply for our maintenance service, please fill in the following form in coordination with the seller and safe-keep it. Thank you!

Product Information	Model	Product Code Number
Customer Information	Name	Contact Number
	Address	
Seller Information	Name	
	Contact Number	
	Address	
	Date of Sale	
Note		

Note: This form shall be sealed by the seller.

Applicable Products

The document applies to the products listed on the Product Maintenance Information (see below for further information). Other products or accessories (e.g. promotional items, giveaways and additional accessories attached, etc.) are not included in this warranty scope.

Warranty Period

The warranty period of products and accessories is implemented according to the relevant Product Maintenance Information. The warranty period is calculated from the day (purchase date) when the product is bought for the first time, and the purchase date is considered as the date registered on the warranty card when buying the product.

How to Get the Maintenance Service

If maintenance service is needed, you can directly contact the product distributor or authorized service institutions. You can also contact the Godox after-sale service call and we will offer you service. When applying for maintenance service, you should provide valid warranty card. If you cannot provide valid warranty card, we may offer you maintenance service once confirmed that the product or accessory is involved in the maintenance scope, but that shall not be considered as our obligation.

Inapplicable Cases

The guarantee and service offered by this document are not applicable in the following cases: ① The product or accessory has expired its warranty period; ② Breakage or damage caused by inappropriate usage, maintenance or preservation, such as improper packing, improper usage, improper plugging in/out external equipment, falling off or squeezing by external force, contacting or exposing to the improper temperature, solvent, acid, base, flooding and damp environments, etc; ③ Breakage or damage caused by non-authorized institution or staff in the process of installation, maintenance, alternation, addition and detachment; ④ The original identifying information of product or accessory is modified, alternated, or removed; ⑤ No valid warranty card; ⑥ Breakage or damage caused by using illegally authorized, nonstandard or non-public released software; ⑦ Breakage or damage caused by force majeure or accident; ⑧ Breakage or damage that could not be attributed to the product itself. Once met these situations above, you should seek solutions from the related responsible parties and Godox assumes no responsibility. The damage caused by parts, accessories and software that beyond the warranty period or scope is not included in our maintenance scope. The normal discoloration, abrasion and consumption are not the breakage within the maintenance scope.

Maintenance and Service Support Information

The warranty period and service types of products are implemented according to the following Product Maintenance Information:

Product Type	Name	Maintenance Period(month)	Warranty Service Type
Parts	Circuit board	12	Customer sends the product to designated site
Other Items	Lamp body, lamp cover, locking device, package, etc.	No	Without warranty

Godox After-sale Service Call +86-755-29609320(8062)

合格证

QC PASS



Wechat
Official Account
神牛微信公众号

深圳市神牛摄影器材有限公司

地址：深圳市宝安区福海街道塘尾社区耀川工业园厂房 2 栋

电话：0755-29609320 (8062) 传真：0755-25723423

邮箱：godox@godox.com

GODOX Photo Equipment Co., Ltd.

Add.: Building 2, Yaochuan Industrial Zone, Tangwei Community,
Fuhai Street, Bao'an District, Shenzhen 518103, China

Tel: +86-755-29609320(8062) Fax: +86-755-25723423

E-mail: godox@godox.com

www.godox.com

Made in China | 705-MA5R00-00

UK
CA CE FCC

