

合格证  
QC PASS

Godox

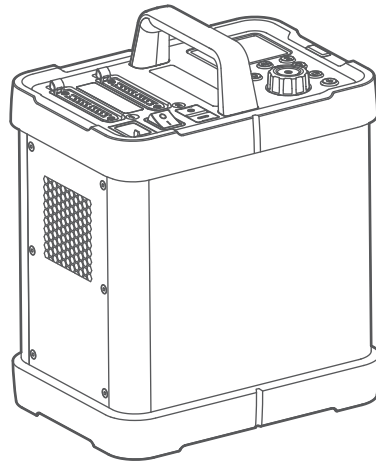

### 深圳市神牛摄影器材有限公司

地址：深圳市宝安区福海街道塘尾社区耀川工业园厂房 2 栋  
电话：0755-29609320（8062） 传真：0755-25723423 邮箱：godox@godox.com

### GODOX Photo Equipment Co., Ltd.

Add: Building 2, Yaochuan Industrial Zone, Tangwei Community, Fuhai Street, Bao'an District,  
Shenzhen 518103, China Tel: +86-755-29609320(8062) Fax: +86-755-25723423  
E-mail: godox@godox.com

[www.godox.com](http://www.godox.com)

Made in China | 705-P24000-03



# P2400

电箱  
Power Pack

使用手册  
Instruction Manual

# 目录

01	前言	17	其他应用
02	安全须知	17	保护功能
03	部件名称	18	规格参数
03	电箱	19	固件升级
04	液晶显示屏	19	维护保养
04	标配物品		
05	可选购附件		
05	供电方式		
06	操作说明		
06	开机		
06	选灯		
06	造型灯		
08	无线模式选择		
08	2.4G 无线模式		
10	433M 无线模式		
10	闪光模式 - 手动闪光		
11	闪光持续时间		
11	色温恒定		
12	闪光模式 -Multi: 频闪闪光		
13	计算快门速度		
13	闪光次数 / 闪光频率 = 快门速度		
14	最大频闪闪光次数		
14	S1 光控同步引闪		
15	S2 光控防预闪引闪		
15	设置自定义功能		

## 本说明书中使用的约定

- 此使用说明中的操作步骤假定相机、电箱和闪光灯的电源开关已开启。
- 此使用说明中使用以下警告符号。

 该“小心”符号表示避免出现拍摄问题的警告。

 该“注意”符号提供补充信息。

## 前言

### 在使用本产品之前

请先仔细阅读本手册,以确保您能安全使用。

请保存好本手册以备将来查询参考。

### 感谢您购买神牛产品!

神牛 P2400 是一款拥有 2400Ws 强劲功率、可无线控制、色温恒定、输出稳定的闪光灯电箱,内置神牛 2.4G 无线 X 系统和 433M 无线系统。

另购 H2400P 闪光灯头,再配合 Xpro、X1、X2 系列或 FT-16 触发器可远程控制灯头闪光,拍摄轻松自如。

### 主要特点:

- **色温恒定**  
全程档位波动± 75K 范围内 (色温恒定模式)。
- **LED 造型灯**  
60W 大功率 LED 造型灯,高亮度自由调节。
- **无线兼容**  
内置神牛 2.4G 无线 X 系统及 433 无线系统,无线兼容 Xpro, X1, X2 系列和 FT-16 触发器,同时设有 2 个 3.5mm 同步插孔,可实现多种同步触发方式。
- **闪光持续时间**  
闪光持续时间 (t0.1) 最快可达约 1/17800s。
- **2 种闪光模式**  
手动闪光和 Multi 频闪光。
- **精准调光**  
功率调节档位 (1.0-10), 每档以 0.1 为增量, 91 级精确微调, 光效把握更随心。
- **两个灯头插座**  
可同时使用两个灯头,也可使用一个灯头,布光更随心。
- **光控引闪**  
S1 光控同步引闪 / S2 光控防预闪引闪。

- **延时闪光**

具备延时闪光 0.01~30 秒,可作为后帘引闪。

- **具有蒙板功能**

便于后期修图,能够快速高效抠出拍摄物体的每一个微小细节。

- **3.5 英寸彩屏**

显示直观,操作更加简易

## 安全须知

- ⚠ 请保持干燥。
- ⚠ 请勿私自拆卸产品,如产品出现故障须由本公司或授权的维修人员进行检查维修。
- ⚠ 请勿让儿童接触本产品。
- ⚠ 请勿放置在超过 50 度的高温环境中。
- ⚠ 请勿在化学品、可燃性气体或其他特殊物质附近使用电箱,这些物质在特殊情况下可能导致火灾或电磁干扰。在这些场合下,请注意相关警告标识。
- ⚠ 本产品不能防水,在雨天及潮湿环境下请注意防水。
- ⚠ 若发生任何故障,请立即关闭电箱电源。

## 部件名称

### 电箱

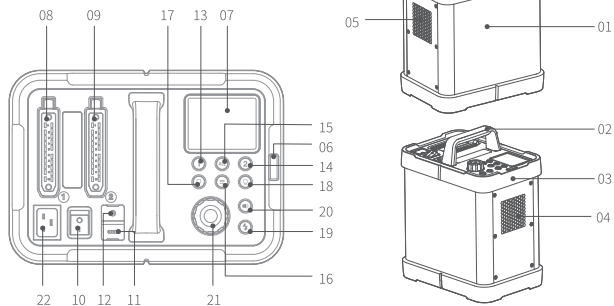

- |                   |                        |
|-------------------|------------------------|
| 01. 箱体            | 12. 3.5mm 同步插孔         |
| 02. 提手            | 13. 1号灯选择调节键           |
| 03. 保护套           | 14. 2号灯选择调节键           |
| 04. 风扇入风口         | 15. ALL 两灯同时调节键        |
| 05. 风扇出风口         | 16. < ≡ > 菜单按钮         |
| 06. 光控灯罩          | 17. < ☹ > 造型灯按钮        |
| 07. 显示屏           | 18. < ☹ > 造型灯按钮        |
| 08. 灯头电源线插槽 1     | 19. < ⚡ > 试闪按钮 / 回电指示灯 |
| 09. 灯头电源线插槽 2     | 20. < 🔊 > 蜂鸣器按钮        |
| 10. 电源开关          | 21. 调节拨轮               |
| 11. Type-C 固件升级插孔 | 22. 电源插座               |

### 液晶显示屏

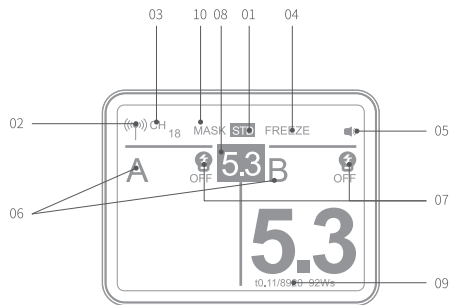

- |                 |             |
|-----------------|-------------|
| 01. STD 回电速度    | 06. 组别 (GR) |
| 02. 无线电传输无线拍摄   | 07. 造型灯     |
| 03. 频道 (CH)     | 08. 功率等级    |
| 04. FREEZE 色温恒定 | 09. 闪光持续时间  |
| 05. 蜂鸣器         | 10. MASK 蒙版 |

## 标配物品

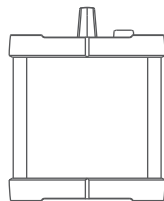

电箱 × 1



电源线 × 1



说明书 × 1

## 可选附件

P2400 电箱可搭配本公司以下摄影附件使用，以获得最佳的拍摄效果和使用体验：

H2400P 灯头、Xpro 引闪器、X1 引闪器、X2 引闪器、XT16 发射器、柔光箱、雷达罩、折叠柔光伞、束光筒、灯架、H2400P5 米灯头延长线 EC2400、H2400P10 米灯头延长线 EC2400L 等。

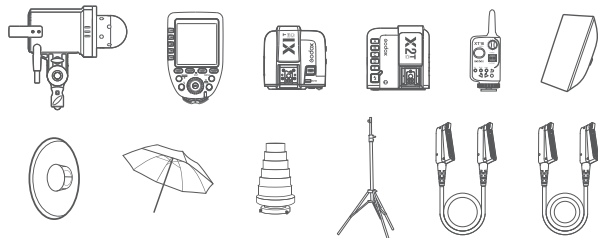

## 供电方式

AC 电源供电：

将电源线输出端插入电箱电源插座，接通电源。

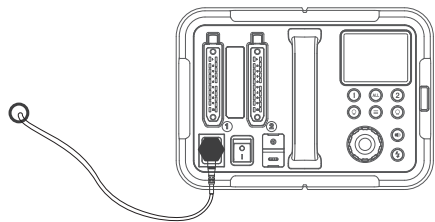

## 操作说明

### 开关电箱

接通电源，将电源开关拨至“-”，即可开机。

将电源开关拨至“o”，即可关机。

注：不使用闪光灯电箱时，请将电源线拔掉。

### 灯头调节

根据灯头所连接的电源线插槽 1 或插槽 2，短按对应按键 1 或按键 2 进行调节设置。短按 ALL 按键两灯可同时进行调节。

注：当 1200Ws 灯头与 2400Ws 灯头同时插入闪光灯电箱，1200Ws 灯头对应的显示屏显示“不兼容 Not Compatible”。此状态下，1200Ws 灯头不能工作，2400Ws 灯头正常工作。

### 造型灯

P2400 电箱配置 60W LED 造型灯，无极调控，2 种长亮模式：百分比和 PROP。

造型灯有 3 种设置模式：OFF，百分比（1%~100%）和 PROP。短按灯头对应的造型灯按键设置模式依次出现在显示屏上。

1. OFF：关闭造型灯。

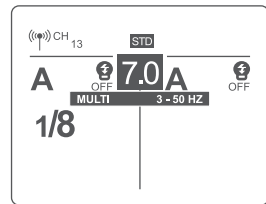
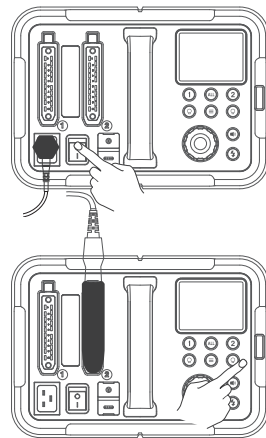

2. 百分比: 1%~100% (为防止过热温度 < 45° 风扇低速转, > 45° 风扇高速转)。

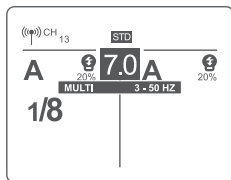

3. RPOP: 通过改变输出功率来调整造型灯亮度, 功率越大造型灯越亮 (为防止过热温度 < 45° 风扇低速转, > 45° 风扇高速转)。

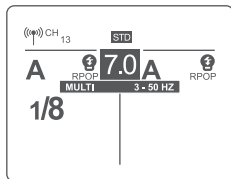

4. 造型灯具有持续和闪灭功能, 可短按 < ≡ > 按键进入主菜单, 旋转调节拨轮选择造型灯, 短按一次调节拨轮, 然后旋转调节拨轮选择“持续”或“闪灭”。再按 < ≡ > 菜单按键返回主界面。



5. 造型灯模式中选中百分比之后, 长按造型灯按钮, 再旋转调节拨轮进行亮度调节 (1~100%)。

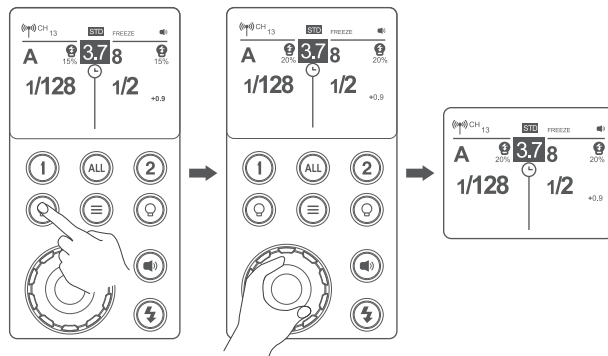

## 无线模式选择

P2400 电箱内置 2.4G 和 433MHz 无线模块, 作为从属单元(接收端), 通过进入菜单选择无线开 / 关、2.4G 或 433M 无线模式。

按 < ≡ > 菜单按键进入主菜单, 旋转调节拨轮选择无线, 短按一次调节拨轮, 然后旋转调节拨轮选择 2.4G 或 433M 无线系统, 最后按 < ≡ > 菜单按键返回主界面, 屏幕左上角显示 < ≡ >。

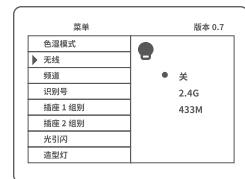

### • 2.4G 无线模式

选择 2.4G 无线传输, 请另外购买 XPro 或 X1 系列、X2 系列触发器。如果在拍摄现场不止一个无线闪光系统, 您可以通过更改通讯频道 (CH)、识别号 (ID)、组别 (GR) 来防止信号干扰。保证主控单元和从属单元设置为相同的频道 (CH)、识别号 (ID)、组别 (GR) 编号即可。

1. 频道 (CH) 设置: 短按 < ≡ > 菜单按键进入菜单, 旋转调节拨轮选择频道 (CH), 短按一次调节拨轮, 然后旋转调节拨轮选择频道 (1~32)。

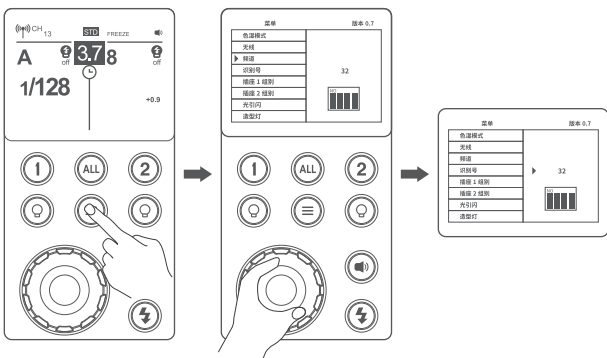

2. 识别号(ID)设置: 短按 < ≡ > 菜单按键进入菜单, 旋转调节拨轮选择识别号, 短按一次调节拨轮, 然后旋转调节拨轮选择 ID 号 (OFF/01~99)。

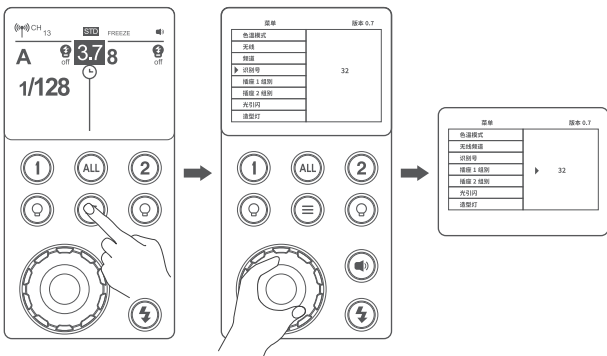

3. 组别 (GR) 设置: 短按 < ≡ > 菜单按键进入菜单, 旋转调节拨轮选择插座 1 或插座 2 对应的组别, 短按一次调节拨轮, 然后旋转调节拨轮选择组别 (0~9/A、B、C、D、E、F)。

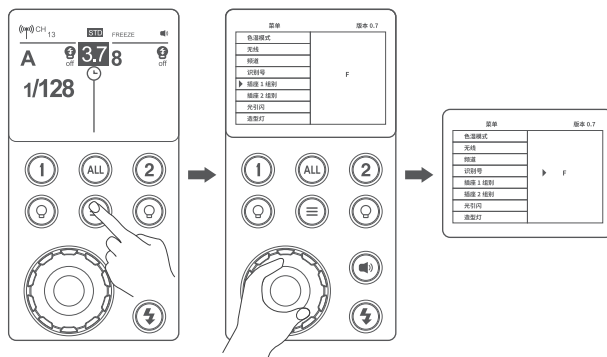

### • 433M 无线模式

选择 433M 无线传输, 请另外购买 FT-16 遥控器。将遥控器与电箱的频道 (CH), 组别 (GR) 设为一致即可。

更多遥控器的使用方法, 请查阅 FT-16 遥控器说明书。



## 闪光模式-手动闪光

您可以在 1.0~10 全功率间以 0.1 档为增量设置闪光输出。为获得正确的闪光曝光, 请使用手持的闪光测光表确定所需的闪光输出。

1. 短按 < ≡ > 菜单按键按钮进入菜单, 旋转调节拨轮选择频闪, 短按一次调节拨轮, 再旋转调节拨轮选择“关”, 最后短按按 < ≡ > 菜单按键返回主界面。2. 通过旋转调节拨轮设置闪光输出功率。

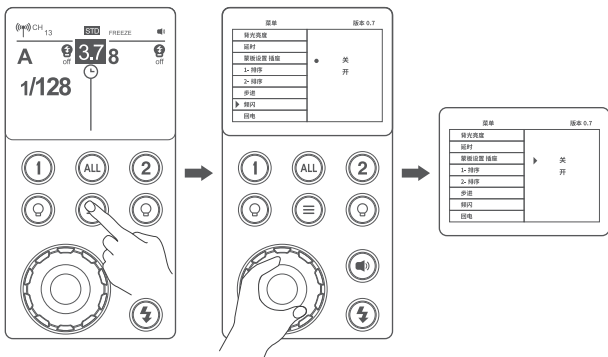

## 闪光持续时间

闪光持续时间是指闪光灯从开始发光到达发光半峰值的时间长度。半峰值的表示为  $t=0.5$ 。为了给摄影师提供更详细的拍摄数值，本产品采用  $t=0.1$ 。如下图： $t=0.5$  与  $t=0.1$  区别。

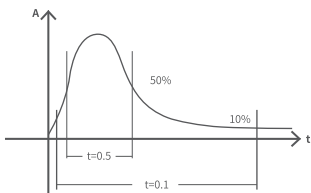

## 色温恒定

使用此功能全档位色温漂移到 75K 以内。短按  $\langle \equiv \rangle$  菜单按键进入主菜单，旋转调节拨轮选择色温模式，短按一次调节拨轮，然后旋转调节拨轮选择“普通”或者“最优”，此时  $\langle \text{闪电} \rangle$  引闪按钮指示灯会闪烁，蜂鸣器出现提示，此时请按引闪按钮放电，方可正常使用。

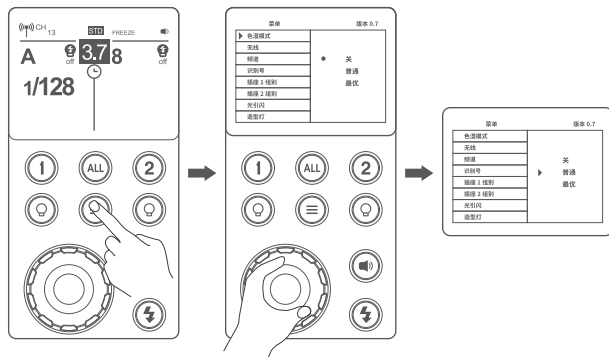

## 闪光模式-Multi：频闪闪光

使用频闪闪光，可以发出一系列快速的闪光。它可以在一张照片上拍摄移动物体的多个图像。

您可以设置闪光频率（每秒的闪光次数，以 Hz 表示）、闪光次数和闪光输出。

- 短按  $\langle \equiv \rangle$  菜单按键进入菜单，旋转调节拨轮选择频闪，短按一次调节拨轮，再旋转调节拨轮选择“开”，最后短按  $\langle \equiv \rangle$  菜单按键返回主界面。
- 设置闪光频率和闪光次数
  - 按调节拨轮选择闪光次数，旋转调节拨轮设定数字。
  - 按调节拨轮选择闪光频率，旋转调节拨轮设定数字。
  - 设置好后按调节拨轮确定。



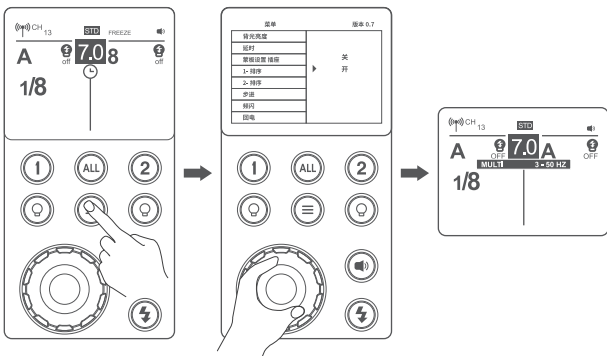

### 计算快门速度

在频闪闪光过程中，到闪光停止为止快门应保持开启状态。使用下面的公式计算快门速度，然后用相机进行设置。

### 闪光次数 / 闪光频率 = 快门速度

例如，如果闪光次数是 10，闪光频率是 5 Hz，快门速度则至少为 2 秒。



- 反光很强的被摄体在暗背景前使用频闪闪光更加有效。
- 建议配合三角架和遥控器使用(需要另购)。
- 频闪闪光时也可以使用“buLb”。
- 如下表所示，闪光次数将受到限制。

### 最大频闪闪光次数

闪光输出 \ Hz	1	2	3	4	5	6-7	8-9	10	11	12-14	15-19	20-50	60-99
1/4	7	6	5	4	3	3	3	2	2	2	2	2	2
1/8	20	15	12	10	8	6	5	4	4	4	4	4	4
1/16	30	30	30	20	20	20	10	8	8	8	8	8	8
1/32	60	60	60	50	50	40	30	20	20	20	18	16	12
1/64	90	90	90	80	80	70	60	50	40	40	35	30	20
1/128	100	100	100	100	100	90	80	70	70	60	50	40	40
1/256	100	100	100	100	100	90	80	70	70	60	50	40	40
1/512	100	100	100	100	100	90	80	70	70	60	50	40	40

### S1 光控同步引闪

短按 < ≡ > 按钮进入菜单，旋转调节拨轮选择光引闪，短按一次调节拨轮，再旋转调节拨轮选择 S1 功能，闪光灯可作为副灯使用，创造多种照明效果，适用于手动闪光环境。它会与主闪光灯的第一次闪光同步触发闪光，效果与使用无线引闪器一致。

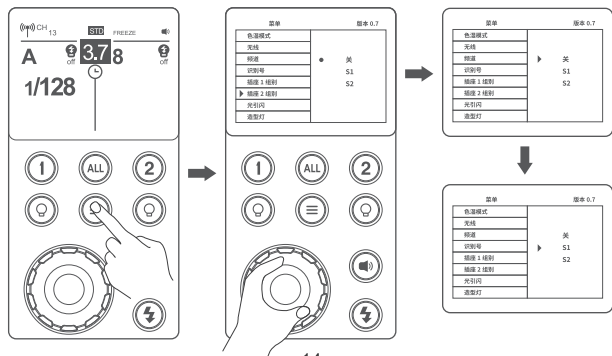

## S2 光控防预闪引闪

短按 < ≡ > 按钮进入菜单, 旋转调节拨轮选择光引闪, 短按一次旋转调节拨轮, 再旋转调节拨轮选择 S2 功能, 闪光灯可作为副灯使用。具有防预闪功能, 使用带一次预闪功能的相机能用光控实现同步拍摄。它会与主闪光灯的第二次闪光同步触发闪光, 即 2 次光控引闪。

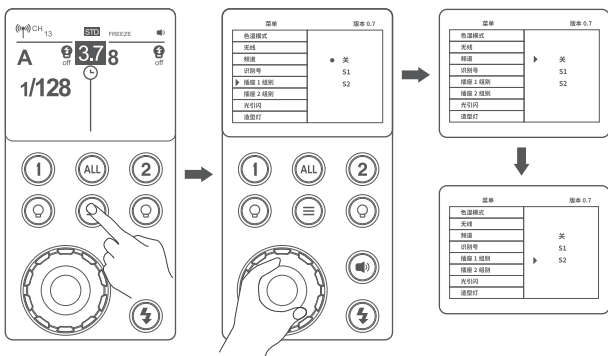

## 设置自定义功能

- 短按 < ≡ > 菜单按钮进入 MENU 菜单, 旋转调节拨轮选择自定义功能。
- 短按一次调节拨轮, 然后旋转调节拨轮选择功能设置。
- 最后短按一次调节拨轮返回 MENU 菜单或短按 < ≡ > 按钮返回主界面。

MENU设置自定义功能			
自定义功能	设置	设置和说明	使用范围限制
色温模式	关	关闭	
	普通	开启	色温恒定模式
	最优		全功率档位波动±75K
无线	关	关闭	
	2.4G	2.4G无线模块	
	433M	433MHz无线模块	
频道	1~32	可以选择1~32任意一个数字	

识别号	关	关闭	无线模式
	01-99	可以选择01-99任意一个数字	
插座1组别 插座2组别	0-9/A,B, C,D,E,F	可以选择0-9/A、B、C、D、E、F中任意一个组别	插座1组别选择 插座2组别选择
光引闪	关	关闭	
	S1	S1光控同步引闪	
	S2	S2光控防预闪引闪	
造型灯	持续	常亮	
	闪灭	闪光灯回电灭	
背光亮度	-3、-2、-1、 0、1、2、3	7个级别	
延时	关	关闭	
	0.01~30秒	可作为后帘引闪	
蒙板设置插座	2蒙板		
	3排序		
	4排序		
1-排序 2-排序	关 1、2		
步进	1.0-10	显示功率方式为数形式	
	1/512-1/1	显示功率方式为分数形式	
频闪	关	关闭频闪	
	开	开启频闪	
回电	标准回电模式	110V标准回电模式4秒内、220V 标准回电模式2秒内	
	最快回电模式	110V最快回电模式2秒内、220V 最快回电模式1秒内, 回电快至0.7秒	
语言	ENGLISH 中文 (简)		
重置	否		
	是	恢复出厂设置	
次序	16976	引闪次数记录	

## 其他应用

### 同步插孔触发

闪光灯外置 2 个同步插孔，配合特定遥控器使用，您可以实现对闪光灯的无线触发。触发器的接收端插入同步插孔，您也可以将发射端置于相机热靴上，通过相机快门来进行同步引闪。同步插孔规格为 3.5mm，此处可插入同步线或者触发器触发插头对闪光灯进行同步引闪。



- 触发器的使用方法，请查阅触发器的说明书。

## 保护功能

### 1. 过热保护功能

- 为防止闪光灯过热并损坏，最大档连续闪多次后，热保护功能被激活，显示屏上出现 。此时如果继续闪光回电变慢，要让闪光灯至少冷却 5 分钟。闪光灯才会恢复正常，热保护符号才会消失。

### 2. 其他保护

- 为了保证设备安全地工作，系统时刻进行预防保护，以下提示符号供您参考：

LCD显示	警示内容
E1	闪光灯回电系统出现问题，无法回电引闪，请重新开机，如无法解决请维修
E3	闪光灯管两端电压过高，请维修
E6	闪光灯风扇发生故障
E9	固件升级有误，请进行正确固件升级

## 规格参数

型号	P2400
输入	100-240V~ 50/60Hz 8A
最大能量	2400Ws
闪光持续时间	最快≈1/17800秒 (t0.1)
功率调节	1.0-10 (1/512-1/1) (十档可调，每档以+0.1为增量)
色温恒定	全程档位波动±75K
闪光模式	手动闪光
	Multi频闪光
频闪闪光	具备 (最大次数: 100次; 最大频率: 100)
延时引闪	0.01~30秒
蒙板	✓
风扇	✓
蜂鸣器	✓
造型灯(LED) 功率	单灯头60W
光控引闪	S1光控同步引闪/S2光控防预闪引闪
显示闪光持续时间	✓
显示	3.5inch彩屏
<b>2.4G无线传输</b>	
无线功能	从属单元，关闭
可控制从属单元组	16组: 0-9/A, B, C, D, E, F
传输范围	约100m
频道	32个: 1~32
无线ID	99个: 01-99
<b>433MHz无线传输</b>	
无线功能	从属单元，关闭
可控制从属单元组	16组: 0-9/A, B, C, D, E, F
传输范围	约30米
频道	32个: 1~32

电源	
电源	AC电源供电
回电时间	最快回电时间≈0.7秒
同步触发方式	3.5mm同步线
工作环境温度	-10°C~45°C
尺寸	
体积	330*287*202mm
净重	≈11Kg

## 固件升级

- 本品出厂不配 USB 升级线, 请另行购买。本产品 USB 接口为 Type-C 接口, 请使用 Type-C USB 线。
- 产品升级固件需要 Godox G3 程序软件支持, 升级固件前请先下载安装“Godox G3 固件升级软件”再选择相应的固件文件。
- 由于产品进行固件升级, 说明书请以最新电子版为准。

## 维护保养

- 产品在工作时, 如发现异常, 应立即关掉电源, 查明原因。
- 产品应避免震动, 平时注意表面除尘。
- 产品的所有维修概由本厂指定的可供原厂配件的维修部负责。
- 1 年保修, 消耗品如灯管等, 不在 1 年保修范围。
- 经发现, 擅自检修此产品的, 将取消产品之一年保修期, 维修需要收取相关费用。
- 如果本品出现故障或者被水淋湿, 在专业人员维修后方可继续使用。
- 如有技术更改, 恕不另行通知。

# Contents

21	<b>Foreword</b>	38	<b>Sync Triggering</b>
22	<b>Warning</b>	38	<b>Protection Function</b>
23	<b>Name of Parts</b>	39	<b>Technical Data</b>
23	Power Pack	40	<b>Firmware Upgrade</b>
24	<b>Display</b>	40	<b>Maintenance</b>
24	<b>Included Accessories</b>		
25	<b>Optional Accessories</b>		
25	<b>Power Supply</b>		
26	<b>Operation</b>		
26	Power On		
26	Light Selection		
26	Modeling Lamp		
28	<b>Wireless Mode Selection</b>		
29	2.4G Wireless Mode		
31	433MHz Wireless Mode		
31	<b>Flash Mode— M Manual Flash</b>		
32	<b>Display Flash Duration</b>		
32	<b>Stable Color Temperature Function</b>		
33	<b>Flash Mode—Multi: Stroboscopic Flash</b>		
33	Calculating the Shutter Speed		
33	Number of Flashes / Flash Frequency = Shutter Speed		
34	Maximum Stroboscopic Flashes:		
34	<b>Optic S1 Secondary Unit Setting</b>		
35	<b>Optic S2 Secondary Unit Setting</b>		
36	<b>Setting Custom Functions</b>		

## Conventions used in this Manual

- This manual is based on the assumption that both the camera, power pack and camera flash's power switches are powered on.
- The following alert symbols are used in this manual:
  - ⚠ The Caution symbol indicates a warning to prevent shooting problem.
  - 📌 The Note symbol gives supplemental information.

## Forward

### Before using this product

Please read this manual carefully to make sure the correct operation and exert the optimum function. And well keep it for future reference.

### Thank you for purchasing !

Godox P2400 is a Power Pack with 2400Ws strong power, stable output, constant color temperature, and built-in GODOX 2.4G and 433M wireless system. Collocate with a H2400P Flash Head(optional), the ultra-bright LED Modeling light, and with P2400 built-in 2.4G wireless X system and 433MHz wireless, it is compatible with Godox triggers like XPro, X1 and X2 and FT-16.

### The P2400 offers:

- Stable Color Temperature Mode:  
color temperature changes within  $\pm 75K$  over the whole power range(stable color temperature mode).
- LED Modeling Lamp:  
60W LED modeling lamp and light brightness can be freely adjusted.
- Wireless Compatibility:  
With built-in Godox 2.4G wireless system and 433MHz wireless system, it is wirelessly compatible with Xpro, X1, X2 series and FT-16, and is equipped with 2 pieces 3.5mm sync jacks, which can realize a variety of synchronous triggering methods.
- Flash Duration:  
The flash duration (t0.1) max. can up to 1/17800s.
- 2 Kinds of Flash Modes:  
Supports manual flash and Multi flash.
- Precise Power Control:  
Precisely control the power settings in 0.1 stop increment from 1.0 to 10, and 91 stops in total.
- 2 Power Sockets:  
Double power sockets for using one or two flash heads.
- Optical Triggering:

S1/S2 Secondary Unit Setting and Secondary Unit Setting with anti-preflash

- Delay Flash:  
0.01 to 30s, can be served as second-curtain sync.
- With Mask Feature:  
Greatly saving your post-production time and money.
- 3.5 Inch Colors Display:  
Intuitive display and precious control.

## Warning

- ⚠ **Always keep this product dry. Do not use in rain or in damp conditions.**
- ⚠ **Do not disassemble. Should repairs become necessary, this product must be sent to an authorized maintenance center.**
- ⚠ **Keep out of reach of children.**
- ⚠ **Do not use the product in the presence of flammable gases, chemicals and other similar materials. In certain circumstance, these materials may be sensitive to the strong light emitting from this product and fire or electromagnetic interference may result.**
- ⚠ **Do not leave or store the flash unit if the ambient temperature reads over 50°C. Otherwise the electronic parts may be damaged.**
- ⚠ **As this product do not have waterproof function, please take measures of waterproof in rainy or damp environment.**
- ⚠ **Turn off the power pack immediately in the event of malfunction.**

## Name of Parts

### Power Pack:

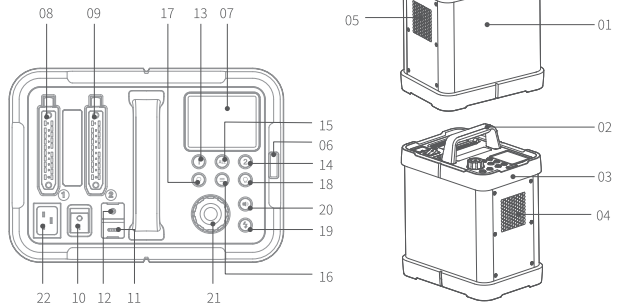

- |   |  |
|---|--|
| 01. Power Pack Body                               | 12. 3.5mm Sync Cord Jack                     |
| 02. Handle  | 13. Adjustment Button for No. 1 Light        |
| 03. Protect Cover                                 | 14. Adjustment Button for No. 2 Light        |
| 04. Fan Inlet                                     | 15. All Adjustment Button for Both Lights    |
| 05. Fan Outlet                                    | 16. ≡ > Menu Button                          |
| 06. Optical Light Cover                           | 17. < Q > Modeling Button                    |
| 07. Control Panel                                 | 18. < Q > Modeling Button                    |
| 08. Power Socket 1 for Flash<br>Head's Power Cord | 19. < ⚡ > Test Button/ Flash Ready Indicator |
| 09. Power Socket 2 for Flash<br>Head's Power Cord | 20. < 🔔 > Beep Button                        |
| 10. Power Switch                                  | 21. Select Dial                              |
| 11. Type-C Firmware Upgrade Port                  | 22. Power Socket                             |

## Display

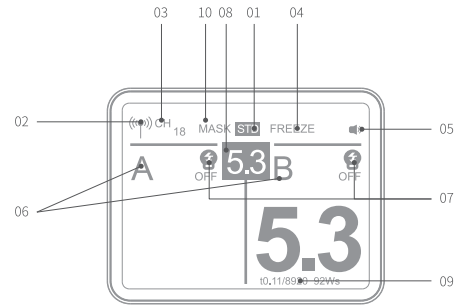

- |   |                   |
|---|-------------------|
| 1. STD Recycle                          | 6. Group (GR)     |
| 2. Radio Transmission Wireless Shooting | 7. Modeling Lamp  |
| 3. Channel (CH)                         | 8. Power Level    |
| 4. FREEZE Stable Color Temperature      | 9. Flash Duration |
| 5. Beeper                               | 10. MASK          |

## Included Accessories

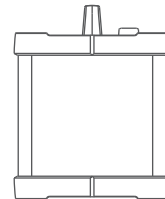

Power Pack × 1



Power Cord × 1



Instruction Manual  
(Including Warranty) × 1

## Optional Accessories

P2400 power pack can be used in combination with the following optional accessories so as to achieve best photography effects:

H2400P Flash head, XPro, X1 and X2 flash trigger, XT16 Transmitter, softbox, beauty dish, umbrella, snoot, light stand, H2400P 5m Head Extension Cord EC2400, H2400P 10m Head Extension Cord EC2400L, etc.

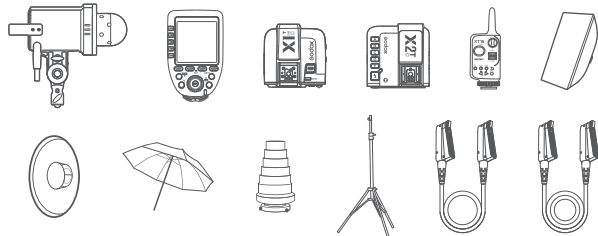

## Power Supply

AC Power Supply: insert the output end of power cord into the power socket of power pack to gain power source.

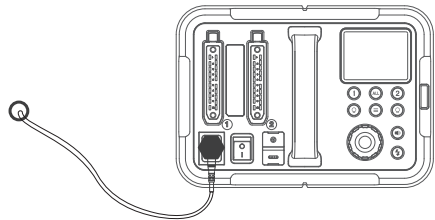

## Operation

### Power On/Off

Slide power switch to "-" to power on;  
Slide power switch to "o" to power off.

Note: Unplug the power cord when the power pack is not being used.

### Flash Light Adjustment

When connecting the flash head (optional) into the power socket 1 or 2, short press the corresponding adjustment button 1 or 2 to set parameters. Short press ALL button to adjust the two lights simultaneously.

Note: When 1200Ws flash head and 2400Ws flash head are plugged into this power pack at same time, the corresponding display screen of the 1200Ws flash head shows "Not Compatible". In this state, the 1200Ws lamp holder cannot work, and the 2400Ws flash head works normally.

### Modeling Lamp

P2400 Power pack is equipped with a 60W LED modeling lamp which has two continuous lighting modes: Percentage and PROP.

There are three modes: OFF, Percentage(1%-100%) and PROP. Short press the Modeling Lamp Button, and the three modes will be displayed on the LCD panel in sequence.

1.OFF: the modeling lamp is off.

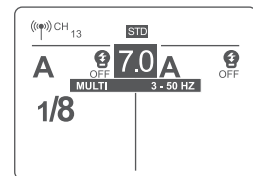
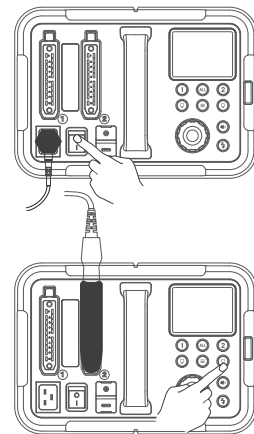



2. Percentage: 1%~100%(to prevent overheat, <45°C the fan rotates in low speed while >45°C in high speed).

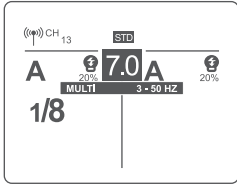

3.PROP: The modeling lamp's power changes with the flash's power. The bigger power the flash has, the brighter the modeling lamp is(to prevent overheat, <45°C the fan rotates in low speed while >45°C in high speed).

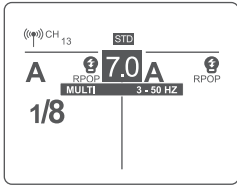

4. Modeling light has continuous and intermittent lighting functions. Short press < ≡ > to enter the main menu, and turn the select dial to select the modeling light, then short press the select dial once and rotate the select dial to select "CONT" or "INTER". Press < ≡ > menu button again to return to the main interface.

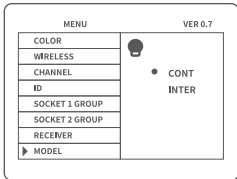

5. Long press the modeling lamp and choose the percentage. Then, turn the select dial to adjust brightness from 1% to 100%.

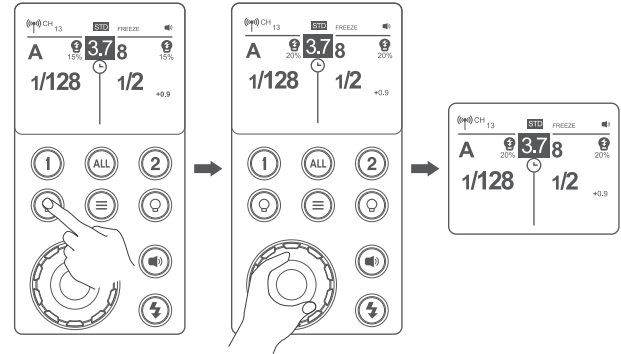

## Wireless Flash Mode

With built-in 2.4G and 433MHz wireless, P2400 power pack can be set as a receiver end. Enter the menu to choose wireless on, off, 2.4G or 433MHz wireless mode.

Press the < ≡ > button to enter the main menu. Turn the select dial to choose wireless. Then, short press the select dial once and turn it to choose 2.4G or 433MHz mode. Press the < ≡ > button to back to the main interface and < (📶) > will be displayed onto the left upper corner of the screen.

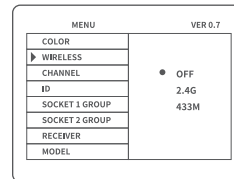

## 2.4G Wireless Mode

When choosing 2.4G wireless transmission, purchase XPro, X1 or X2 series flash triggers (optional) is needed. If there are other wireless flash systems nearby, you can change the channel (CH), identification number (ID) and group (GR) to prevent signal interference. The channels (CH), identification numbers (ID) and groups (GR) of the transmitter unit and the receiver unit must be set to the same.

1.Channel (CH) setting: press the < ≡ > button to enter menu. Turn the select dial to choose channel. Then, short press the select dial once and turn it to choose channel from 1 to 32.

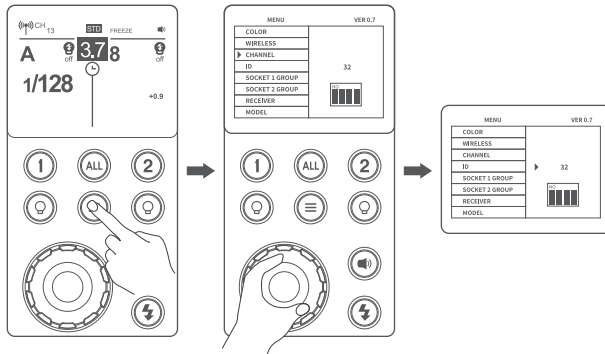

2. Identification number (ID) setting: short press the < ≡ > button to enter menu, turn the select dial to choose ID. Then, short press the select dial once and turn it to choose ID from OFF and 01 to 99.

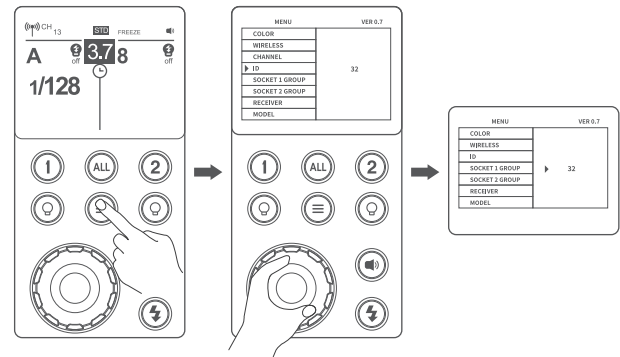

3. Group (GR) setting: short press the < ≡ > button to enter menu, in the menu, turn the select dial to choose the corresponding group of socket 1 or socket 2. Then, short press the select dial once and turn it to choose group from 0 to 9 and A to F.

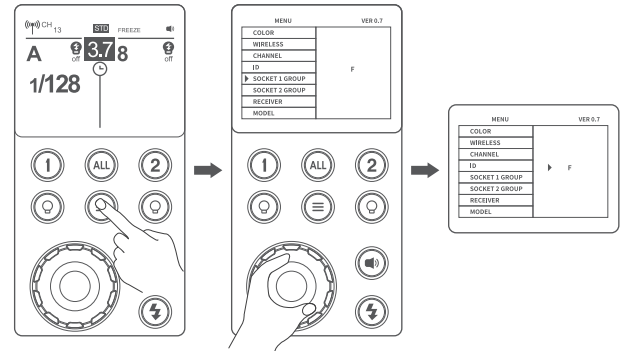

### 433MHz Wireless Mode

When choosing 433MHz wireless transmission, purchase FT-16 remote control (optional) is needed. Please set the channels and groups of remote control to the same with the power pack's.

To get more using details of remote control, please refer to FT-16 instruction manual.

MENU		VER 0.7
COLOR		
WIRELESS		
CHANNEL		
ID		ON
SOCKET 1 GROUP		2.4G
SOCKET 2 GROUP	▶	433M
RECEIVER		
MODEL		

### Flash Mode-----M: Manual Flash

The flash output is adjustable from 1.0 power to 10 power in 0.1 step increments. To obtain a correct flash exposure, use a hand-held flash meter to determine the required flash output.

1. Press < ≡ > button to enter the menu. Turn the select dial to choose multi flash. Then, short press the select dial and turn it to choose "OFF". Press the < ≡ > button to back to the main interface.
2. Turn the select dial to set the flash output.

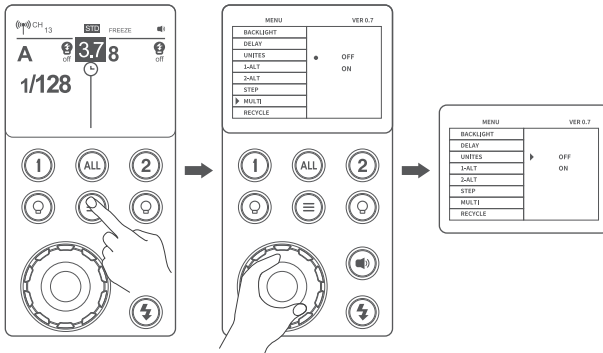

31

### Display Flash Duration

Flash duration refers to the length of time that from flash's firing to reach the half peak at maximum. The half peak at maximum is usually expressed as  $t=0.5$ . In order to provide the photographer with more concrete data, this product adopts  $t=0.1$ . The difference between  $t=0.5$  and  $t=0.1$  is shown in the following picture.

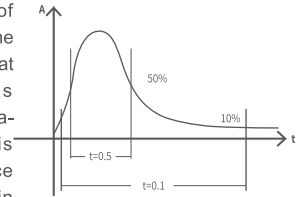

### Stable Color Temperature Function

When use this function, the color temperature changes within  $\pm 75K$  over the entire power range.

Press the < ≡ > button to enter the main menu and turn the select dial to choose color mode. Short press the select dial once and turn it to choose OFF, STD or OPT (STD means regular state, and OPT means optimum state), and Flash Ready Indicator < ⚡ > will blink (the beeper will alarm). Now press the Test Button to discharge, and the flash can be used as normal.

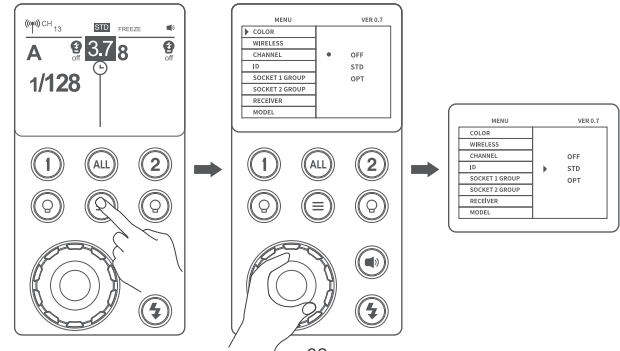

32

## Flash Mode-Multi: Stroboscopic Flash

With stroboscopic flash, a rapid series of flashes is fired. It can be used to capture multiple images of a moving subject in a single photograph. You can set the firing frequency (number of flashes per sec. expressed as Hz), the number of flashes, and the flash output.

1. Press  $\langle \equiv \rangle$  to enter the menu and turn the select dial to choose multi flash. Then, short press the select dial and turn it to choose on. Press the  $\langle \equiv \rangle$  button to back to the main interface.

2. Set the flash frequency and flash times.

- Press the select dial to choose flash times. Turn the Select Dial to set the number.
- Press the select dial to choose flash frequency. Turn the Select Dial to set the number.
- After you finish the setting, press the select dial to confirm.

### Calculating the Shutter Speed

During stroboscopic flash, the shutter remains open until the firing stops. Use the formula below to calculate the shutter speed and set it with the camera.

### Number of Flashes / Flash Frequency = Shutter Speed

For example, if the number of flashes is 10 and the firing frequency is 5 Hz, the shutter speed should be at least 2 seconds.

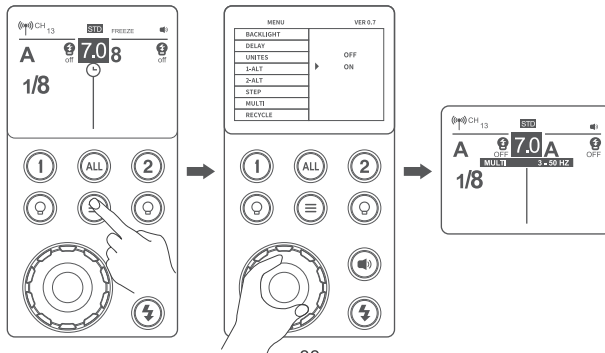

- Stroboscopic flash is most effective with a highly reflective subject against a dark background.
- Using a tripod and a remote control is recommended(Optional).
- Stroboscopic flash can be used with“buLb”.
- The number of flashes will be limited as shown by the following table.

### Maximum Stroboscopic Flashes:

Flash Output \ Hz	1	2	3	4	5	6-7	8-9	10	11	12-14	15-19	20-50	60-99
1/4	7	6	5	4	3	3	3	2	2	2	2	2	2
1/8	20	15	12	10	8	6	5	4	4	4	4	4	4
1/16	30	30	30	20	20	20	10	8	8	8	8	8	8
1/32	60	60	60	50	50	40	30	20	20	20	18	16	12
1/64	90	90	90	80	80	70	60	50	40	40	35	30	20
1/128	100	100	100	100	100	90	80	70	70	60	50	40	40
1/256	100	100	100	100	100	90	80	70	70	60	50	40	40
1/512	100	100	100	100	100	90	80	70	70	60	50	40	40

## Optic S1 Secondary Unit Setting

Press the  $\langle \equiv \rangle$  button to enter menu and turn the select dial to choose receiver. Then, short press the select dial and choose S1 function, so that this flash can function as an optic S1 secondary flash with optic sensor. With this function, the flash will fire synchronously when the main flash fires, the same effect as that by the use of radio triggers. This helps create multiple lighting effects.

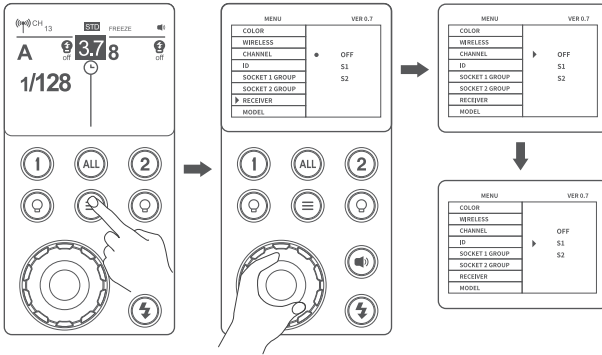

## Optic S2 Secondary Unit Setting

Press the  $\equiv$  button to enter menu and turn the select dial to choose receiver. Then, short press the select dial and choose S2 function, so that this flash can also function as an optic S2 secondary flash with optic sensor. This is useful when cameras have pre-flash function. With this function, the flash will ignore a single “preflash” from the main flash and will only fire in response to the second, actual flash from the main unit.

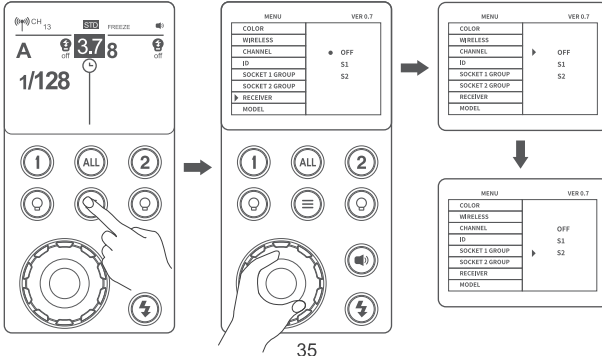

## Setting Custom Functions

1. Press the  $\equiv$  button to enter menu. Turn the select dial to choose custom functions.
2. Short press the select dial and turn it to choose the corresponding functions.
3. Short press the select dial again or short press the  $\equiv$  button to back to the main interface.

MENU Custom Function Settings			
Custom Functions	Settings	Settings & Descriptions	Restrictions
COLOR	OFF	Off	Stable color temperature mode, changes within $\pm 75K$
	STD	On	
	OPT		
WIRELESS	OFF	Off	
	2.4G	2.4G Wireless	
	433MHz	433MHz Wireless	
CHANNEL	1~32	Choose any figure from 1 to 32	
ID	OFF	Off	Wireless mode
	01-99	Choose any figure from 01 to 99	
SOCKET 1 GROUP SOCKET 2 GROUP	0~9/A,B,C,D,E,F	Choose one from 0~9/A,B,C,D,E,F	Choose group of socket 1
			Choose group of socket 2
RECEIVER	OFF	Off	
	S1	S1 Mode	
	S2	S2 Mode	
MODEL	CONT	Always lighting	
	INTER	Off after finishing the flash recycle	
BACKLIGHT	-3~0~3	7 levels	

DELAY	OFF	Off	
	0.01~30s	Can be set as second-curtain sync	
UNITES	2 MASK		
	3 ALT		
	4 ALT		
1-ALT 2-ALT	OFF		
	1,2		
STEP	1.0-10	Display in the form of decimal	
	1/512-1/1	Display in the form of fraction	
MULTI	OFF	Off Multi Flash	
	ON	On Multi Flash	
RECYCLE	STD	Within 4 seconds in 110V standard recycling mode, within 2 seconds in 220V standard recycling mode	
	MAX	Within 2 seconds in 110V fastest recycling mode, within 1 second in 220V fastest recycling mode, and fastest up to 0.7s	
LANGUAGE	ENGLISH		
	Chinese(Simplified)		
RESET	NO		
	YES	Reset to default	
TIMES	16976	Record flash times	

## Sync Triggering

The Sync Cord Jack is a  $\Phi 3.5\text{mm}$  plug. Insert a trigger plug here and the flash will be fired synchronously with the camera shutter. To control the flash wirelessly, you need to insert the receive end of flash trigger into the Wireless Control Port on the flash and insert the transmit end into the

camera hot shoe. Settings made on the hotshoe-mounted transmit and receive ends will be wirelessly communicated to the flash. Then you can press the camera shutter release button to trigger the flash. You can also hold the transmit end at hand to control your off-camera flash. The Sync Cord Jack is a  $\Phi 3.5\text{mm}$  plug. Insert a trigger plug here and the flash will be fired synchronously with the camera shutter.



For full instructions on the use of flash trigger, see its user manual.

## Protection Function

### 1. Over-Temperature Protection

The inner over-temperature protection function may be activated when firing more than 200 continuous flashes in fast succession at 1/1 full power and <img alt="over-temperature icon" data-bbox="618 485 630 505"/> will be displayed. If gets a slower recycle time in firing, please allow a rest time of about 5 minutes, and the flash unit will then return to normal and the <img alt="over-temperature icon" data-bbox="688 535 700 555"/> will disappear.

### 2. Other Protections

The system provides real-time protection to secure the device and your safety. The following lists prompts for your reference:

Prompts on LCD Panel	Meaning
E1	A failure occurs on the recycling system so that the flash cannot fire. Please restart the flash unit. If the problem still exists, please send this product to a maintenance center.
E3	The voltage on two outlets of the flash tube is too high. Please send this product to a maintenance center.
E6	Flash fan failure
E9	There are some errors occurred during the upgrading process. Please using the correct firmware upgrades method.

## Technical Data

<b>Model</b>	<b>P2400</b>
Input	100-240V~ 50/60Hz 8A
Maxi. Power	2400Ws
Flash Duration	Max. ≈1/17800s
Power Adjustment	1.0-10(1/512-1/1)10 levels adjustable, and each level in 0.1 increments
Stable Color Temperature	Change within ±75K during the entire range
Flash Mode	Manual flash
	Multi flash
Stroboscopic Flash	Provided (up to 100 times, 100Hz)
Delay Flash	0.01~30 seconds
Mask	√
Fan	√
Beeper	√
Modeling Lamp(LED)Power	Single lamp holder 60W
Receiver	S1/S2 Secondary Unit Setting
Flash Duration Indication	√
Display	3.5 inch color screen
<b>2.4G Wireless Transmission</b>	
Wireless Function	Receiver, Off
Controllable Receive Groups	16 (0 ~ 9, A ~ F)
Transmission Range (approx.)	100m
Channels	32 (1~32)
Wireless ID	99 (01~99)
<b>433MHz Wireless Transmission</b>	
Wireless Function	Auxiliary, Off
Controllable Receive Groups	16 (0 ~ 9, A ~ F)
Transmission Range (approx.)	Approx.30m
Channels	32 (1~32)
<b>Power Supply</b>	

Power Supply	AC Power Supply
Recycle Time	fastest recycling time ≈ 0.7
Sync Triggering Mode	3.5mm sync line
Working environment temperature	-10°C~45°C
<b>Dimensions</b>	
Dimension	330*287*202mm
Net Weight	11kg

## Firmware Upgrade

This flash supports firmware upgrade through the Type-C port. Update information will be released on our official website.



USB connection line is not included in this product. As the USB port is a Type-C USB socket, please use the Type-C USB line.

- As the firmware upgrade needs the support of Godox G3 software, please download and install the "Godox G3 firmware upgrade software" before upgrading. Then, choose the related firmware file.
- As the products needs to do firmware upgrade, please refer to instruction manual of the newest electric version as final.

## Maintenance

- Shut down the device immediately should abnormal operation be detected.
- Avoid sudden impacts and the product should be dedusted regularly.
- Maintenance of the device must be performed by our authorized maintenance department which can provide original accessories.
- This product, except consumables e.g. flash tube, is supported with a one-year warranty.
- Unauthorized service will void the warranty.
- If the product had failures or was wetted, do not use it until it is repaired by professionals.
- Changes made to the specifications or designs may not be reflected in this manual.

## FCC Statement

This device complies with part 15 of the FCC Rules. Operation is subject to the following two conditions:

- (1) This device may not cause harmful interference, and
- (2) this device must accept any interference received, including interference that may cause undesired operation.

Note: This equipment has been tested and found to comply with the limits for a Class B digital device, pursuant to part 15 of the FCC Rules. These limits are designed to provide reasonable protection against harmful interference in a residential installation. This equipment generates uses and can radiate radio frequency energy and, if not installed and used in accordance with the instructions, may cause harmful interference to radio communications. However, there is no guarantee that interference will not occur in a particular installation. If this equipment does cause harmful interference to radio or television reception, which can be determined by turning the equipment off and on, the user is encouraged to try to correct the interference by one or more of the following measures:

- Reorient or relocate the receiving antenna.
- Increase the separation between the equipment and receiver.
- Connect the equipment into an outlet on a circuit different from that to which the receiver is connected.
- Consult the dealer or an experienced radio/TV technician for help.

## Warning

Operating frequency:433.05MHz – 434.79MHz /2412.99MHz – 2464.49MHz (only receive)

## Declaration of Conformity

GODOX Photo Equipment Co.,Ltd. hereby declares that this equipment are in compliance with the essential requirements and other relevant provisions of Directive 2014/53/EU. In accordance with Article 10(2) and Article 10(10), this product is allowed to be used in all EU member states. For more information of DoC, Please click this web link: <https://www.godox.com/eu-declaration-of-conformity/>  
The device complies with RF specifications when the device used at 0mm from your body.



## 产品保修

尊敬的用户，本保修卡是申请保修服务的重要凭证，请您配合销售商填写并妥善保管，谢谢！

产品信息	型号	产品条码
用户信息	姓名	联系电话
	通信地址	
销售商信息	名称	
	联系电话	
	通信地址	
	销售日期	
备注		

注：此表应由销售商盖章确认。

### 产品信息

本文件适用于相关《产品保修信息》(见后面说明)所列产品，其他非属此范围的产品或部件(如促销品、赠品及其他出厂后附加的部件等)不在此保修承诺内。

### 保修期

产品及部件的相应保修期按相关的《产品保修信息》执行。保修期自产品首次购买日起算，购买日以购买产品时保修卡登记日期为准。

### 如何获得保修服务

您可直接与产品销售商或授权服务机构联系，也可拨打神牛产品售后服务电话，与我们联系，由我们的服务人员为您安排服务。申请保修时，您应提供有效的保修卡作为保修凭证，方可获得保修。如您不能提供有效的保修卡，则在我们确认产品或部件属于保修范围的情况下，也可以为您提供保修，但这不作为我们的义务。

### 不适用保修的情况

如产品存在下列情况，本文件项下的保证和服务将不适用 ①产品或部件超过相应保修期；②错误或不当使用、维护或保管导致的故障或损坏，如：不当搬运；非按产品合理预期用途使用；不当插拔外接设备；跌落或外力挤压；接触或暴露于不适当温度、溶剂、酸碱、水浸或潮湿环境；③由非神牛授权机构或人员安装、修理、更改、添加或拆卸造成的故障或损坏；④产品或部件原有识别信息被修改变更或删除；⑤无有效保修卡；⑥使用非法授权、非标准或非公开发行的软件造成的故障或损坏；⑦因不可抗力或意外事件造成的故障或损坏；⑧其他非因产品本身质量问题导致的故障或损坏。遇上述情况，您应向相关责任方寻求解决，神牛对此不承担任何责任。因非在保修期或保修范围内的部件、附件或软件导致产品不能正常使用的，不是保修范围内的故障。产品使用过程中正常的脱色，磨损和消耗，不是保修范围内的故障。

### 产品保修和服务支持信息

产品的保修期和服务类型按以下《产品保修信息》执行：

产品类别	选件名称	保修期(月)	保修服务类型
部件	主机	12	客户送修
	电池	3	客户送修
	充电器等带电性能的部件。	12	客户送修
其他	如闪光灯管、造型灯泡、外壳、保护罩、锁紧装置、包装等。	无	无保修

神牛产品售后服务电话 0755-29609320-8062

# Warranty

Dear customers, as this warranty card is an important certificate to apply for our maintenance service, please fill in the following form in coordination with the seller and safe-keep it. Thank you!

<b>Product Information</b>	<b>Model</b>	<b>Product Code Number</b>
<b>Customer Information</b>	<b>Name</b>	<b>Contact Number</b>
	<b>Address</b>	
<b>Seller Information</b>	<b>Name</b>	
	<b>Contact Number</b>	
	<b>Address</b>	
	<b>Date of Sale</b>	
<b>Note</b>		

Note: This form shall be sealed by the seller.

## Applicable Products

The document applies to the products listed on the Product Maintenance Information (see below for further information). Other products or accessories (e.g. promotional items, giveaways and additional accessories attached, etc.) are not included in this warranty scope.

## Warranty Period

The warranty period of products and accessories is implemented according to the relevant Product Maintenance Information. The warranty period is calculated from the day (purchase date) when the product is bought for the first time, and the purchase date is considered as the date registered on the warranty card when buying the product.

## How to Get the Maintenance Service

If maintenance service is needed, you can directly contact the product distributor or authorized service institutions. You can also contact the Godox after-sale service call and we will offer you service. When applying for maintenance service, you should provide valid warranty card. If you cannot provide valid warranty card, we may offer you maintenance service once confirmed that the product or accessory is involved in the maintenance scope, but that shall not be considered as our obligation.

## Inapplicable Cases

The guarantee and service offered by this document are not applicable in the following cases: ①. The product or accessory has expired its warranty period; ②. Breakage or damage caused by inappropriate usage, maintenance or preservation, such as improper packing, improper usage, improper plugging in/out external equipment, falling off or squeezing by external force, contacting or exposing to the improper temperature, solvent, acid, base, flooding and damp environments, etc; ③. Breakage or damage caused by non-authorized institution or staff in the process of installation, maintenance, alternation, addition and detachment; ④. The original identifying information of product or accessory is modified, alternated, or removed; ⑤. No valid warranty card; ⑥. Breakage or damage caused by using illegally authorized, nonstandard or non-public released software; ⑦. Breakage or damage caused by force majeure or accident; ⑧. Breakage or damage that could not be attributed to the product itself. Once met these situations above, you should seek solutions from the related responsible parties and Godox assumes no responsibility. The damage caused by parts, accessories and software that beyond the warranty period or scope is not included in our maintenance scope. The normal discoloration, abrasion and consumption are not the breakage within the maintenance scope.

## Maintenance and Service Support Information

The warranty period and service types of products are implemented according to the following Product Maintenance Information:

Product Type	Name	Maintenance Period(month)	Warranty Service Type
Parts	Circuit Board	12	Customer sends the product to designated site
	Battery	3	Customer sends the product to designated site
	Electrical parts e.g.battery charger, etc.	12	Customer sends the product to designated site
Other Items	Flash tube, modeling lamp, lamp body, lamp cover, locking device, package, etc.	No	Without warranty

Godox After-sale Service Call 0755-29609320-8062