

Godox

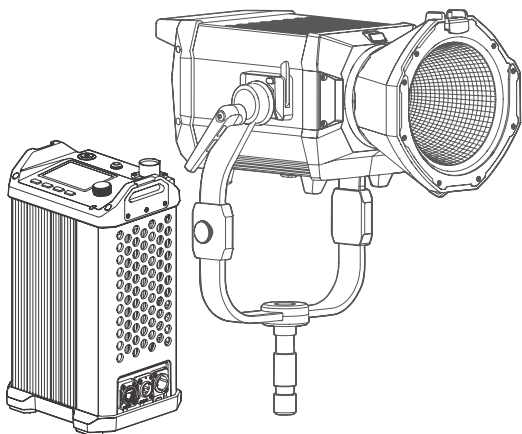

# KNOWLED M600R

诺力全彩 LED 影视灯  
KNOWLED Full color LED Light

使用手册  
Instruction Manual

V1.1 说明书 / Instruction Manual

V1.00 固件 / Firmware

## 重要的安全说明及注意事项

首先作为最基本原则: 本产品为专业灯光布景设备, 应由专业灯光师使用或在专业人士指导下使用。使用时必须始终遵循基本的安全预防措施, 具体安全预防措施如下:

1. 使用前必须阅读并理解产品说明书。
2. 专业灯具, 禁止儿童使用。当儿童靠近时, 家长或监护人必须密切监督, 以免儿童因碰撞灯具或私用灯具造成人身伤害。
3. 本灯具并非普通照明灯具, 不可用于普通照明, 任何有过眼部损伤或眼部敏感的人群均应避免使用本灯具。
4. 灯具点亮时, 必须小心使用, 禁止接触高温部件, 如 LED 灯珠, 以免造成灼伤。
5. 灯具点亮时, 任何情况下均禁止直视灯珠。应该在专业灯光师指导下使用强光, 任何情况下避免长时间处于强光环境, 如引起眼睛不适, 请及时关闭灯具, 暂停使用, 请及时就医。
6. 倘灯珠损坏或因热变形, 应停止使用, 并及时联系制造商、服务代理商或合格的维修人员更换灯珠, 以免发生意外。
7. 本产品仅适用于  $-20^{\circ}\text{C} \sim 45^{\circ}\text{C}$  工作环境温度及正常湿度环境下使用。
8. 请勿使用损坏的设备或设备配件, 待专业维修人员检查维修, 确认设备正常方可使用。
9. 在使用过程中, 如果本产品由于跌落、受到挤压或遭受强烈冲击而造成外壳破裂的, 请勿继续使用, 以免因接触到内部电子元件而受到电击伤害。
10. 如需要延长线, 请使用额定电流 $\geq$ 该设备额定电流的延长线。如延长线额定电流小于该设备, 可能导致过热。
11. 部分产品电源线较长, 请合理放置电源线, 使其处于安全位置。避免电源线接触过热物体表面、避免放置不当导致拉扯损坏或绊倒现场人员。请使用本厂原装电源线, 如使用非本厂电源线导致产品损坏, 概不在本厂维修范围内。
12. 在清洁和维修之前, 请务必从电源插座上拔下该设备插头。不使用时, 禁止拉扯电源线以将设备插头从电源插座中拔出。正常断电, 应是用手抓住该设备插头两端, 将插头从电源插座中拔出。此设备需连接到接地插座中。
13. 请勿私自拆卸产品, 如产品出现故障, 须由本公司或授权的维修人员进行检查维修。
14. 存放本设备之前, 请确保设备已完全冷却。存放时, 将电源线从设备上拔出。设备应放置于设备便携包内或通风干燥处。
15. 请勿将设备放置在酒精、汽油等易燃易挥发的溶剂附近。
16. 本厂不推荐的产品附件, 请勿使用, 以免导致火灾、触电或人身伤害。
17. 清洁本设备时, 请勿用湿布擦拭, 请用干布, 软布擦拭设备污垢。
18. 设备使用前, 请注意将保护罩取下。
19. 本产品已通过 ROHS, CE 和 FCC 认证, 请参考相关国家标准使用和操作。
20. 安全说明依据本厂严格测试制定, 设备设计和规格如有变更, 恕不另行通知。客户可以上神牛官网查看最新的电子版说明, 了解产品最新资讯。
21. 一年保修期, 消耗品电池、适配器、电源线等配件不在此保修范围内。
22. 经发现, 擅自检修设备, 将取消一年保修期, 维修需要收取相关费用。
23. 对于不规范操作引起的机器故障不在保修范围内。

保存这些说明

## 前言

感谢您购买神牛产品。

神牛 M600R 影视灯超强输出功率最大可达 700W，全彩 LED 灯，色温与亮度可调，让不同光色随着主题变化而打造相应氛围。灯珠高亮高显，支持千分级调光，灯体与电源适配器分离，IP54 级防水防尘与多种无线控制的特性能很好地应对室内外工作，专为小场景广告，微电影拍摄以及外景录制等场景提供光源。

## 主要特点

- 最大 700W 的超强输出功率；
- 千分级调节，能从 100%完美平滑调光至 0%；
- 宽广色温，调节范围：1800K-10,000K；
- 平均 CRI  $\geq 96$ ，平均 TLCI  $\geq 96$ ，高彩色还原度；
- 4 种调光曲线：线性、S 曲线、指数、对数；
- 多种控制方式：控制盒、有线 DMX、无线 DMX、蓝牙、以太网；
- 灯头及控制器均有 IP54 防护等级，满足全天候工作；
- 灯头温度低，颜色稳定性好，灯具寿命长；
- 14 种光效模式，满足大部分基本特效需求；

## 警告

- 大功率 LED 灯，严禁直视灯源或照射他人眼睛。
- 严禁通电时插拔电源线，以免造成人身伤害。
- 本灯具工作时，请勿遮挡散热口。
- 请勿让儿童靠近、接触或使用本灯具。
- 专业灯光设备，请务必按照使用手册正确操作。



人眼不可直视

本设备包含型号核准代码为：CMIIT ID: 24J44811A005，为该产品的无线电发射模块。

## 部件名称

### 灯体

1. 把手
2. 方向调节把手
3. 挂绳装置
4. U型支架
5. 卡口推制
6. 保荣卡口
7. 快装装置
8. ACC(配件串口)
9. DC输入接口
10. 28mm支撑柱

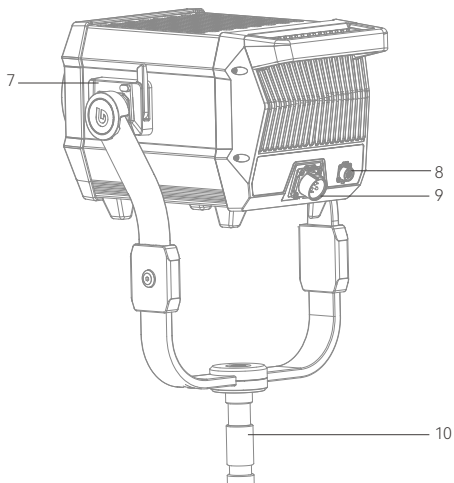
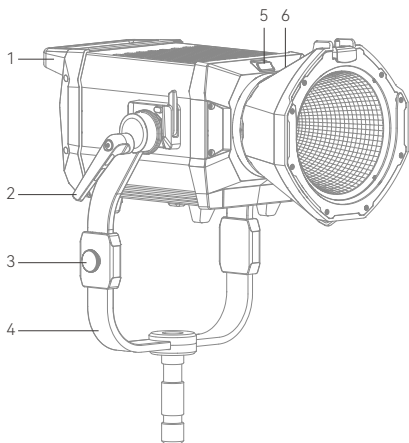

## 控制器

1. 开关按键
2. 离机遥控器接口
3. DC 输出接口
4. 调节旋钮
5. LED 状态灯
6. MODE 按键
7. MENU 按键
8. LOCK 按键
9. PRESET 按键
10. 彩屏
11. DMX OUT 接口
12. DMX IN 接口
13. USB-A 接口
14. AC 输入接口
15. DC 输入接口
16. LAN 接口

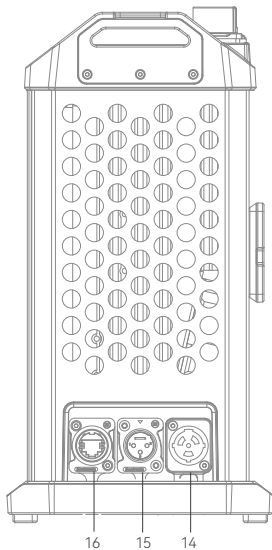
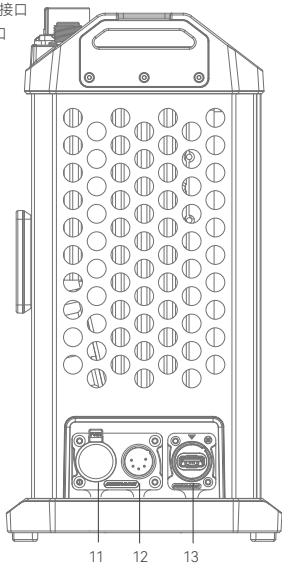
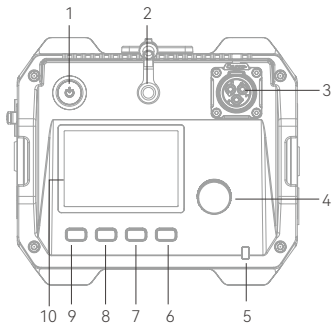

## 物品清单

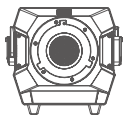

灯体 ×1

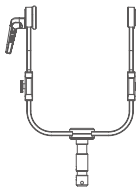

U型支架 ×1

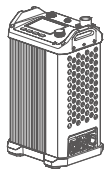

控制器 ×1



反光罩 BR45 ×1

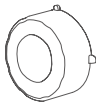

灯头保护罩 ×1



AC电源线 ×1



DC连接线 ×1



绑绳 ×1



安全绳 ×1



控制器固定件 ×1



说明书 ×1



箱包 SC20 ×1

温馨提示：说明书中线图均为示意图，仅供参考。由于产品不断更新与升级，产品实物与线图可能存在差异，请以实物为准。

## 安装与拆卸

### 1. 安装 U 型支架

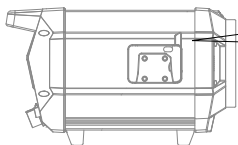

1.1 将灯具放于平面，散热面朝上，灯具四脚朝下，灯珠面朝向自己。

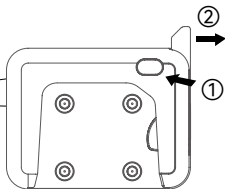

1.2 按住灯体上的快装置按钮，拨开扳手。

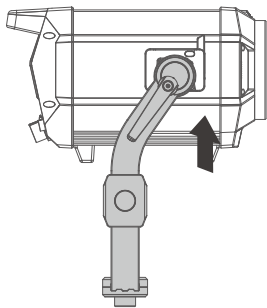

1.3 此时安装 U 架有方向调节把手的在右侧，双手握住 U 架两端，对准快装置由下往上插入，接着将两边扳手锁紧，听到“咔”一声即表示安装完毕。

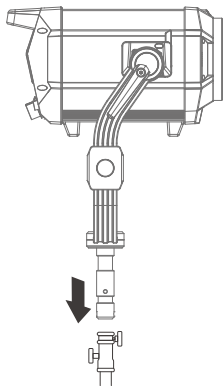

1.4 将灯具安装在滚轮灯架上，锁紧滚轮灯架的固定旋钮。

注：滚轮灯架不包含在标配内，需另购。

⚠ 该灯具重量大，安装需小心谨慎，以免造成人身伤害。

## 2. 拆卸 U 型支架

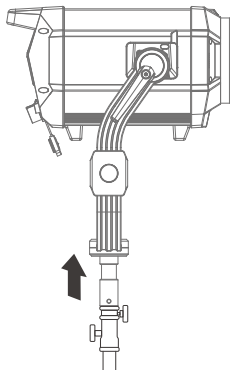

2.1 握住灯具的 U 型架，将灯具从滚轮灯架上取下来放在平面上。

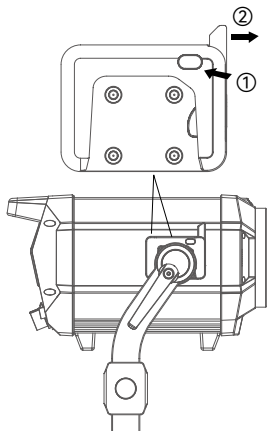

2.2 按住快装装置按钮，拨开扳手，即可将 U 型支架取出。

## 3. 安装 / 拆卸灯头保护罩

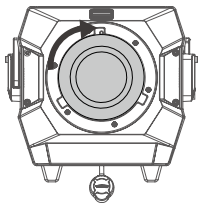

3.1 将灯头保护罩对准灯头卡口，顺时针旋转即可安装完毕。

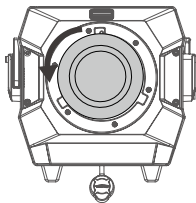

3.2 按住卡口推制，逆时针旋转即可取下灯头保护罩。



#### 4. 安装 / 拆卸灯头反光罩

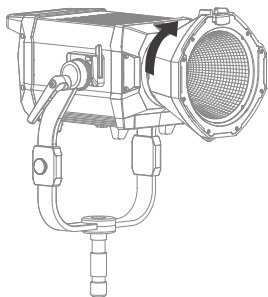

4.1 将反光罩对准灯头卡口，插入后顺时针旋转即可安装完毕。

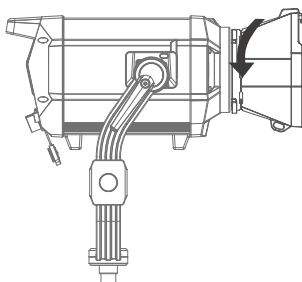

4.2 按住卡口推制，逆时针旋转即可取下灯头反光罩。

注：请务必对准卡口插入

#### 5. 将控制器安装到灯架上

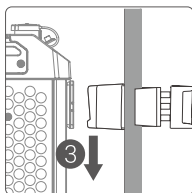
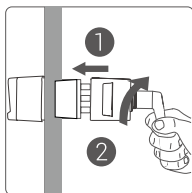

5.1 将控制器固定件把手拧松后插入灯架杆，顺时针旋转把手锁定固定件，最后将控制器快装装置对准固定件卡槽插入即可。

## 6. 连接 DMX 控制台

### 6.1 无线 DMX 连接

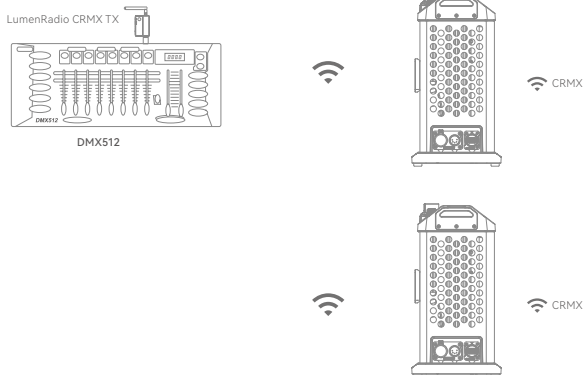

### 6.2 有线 DMX 连接

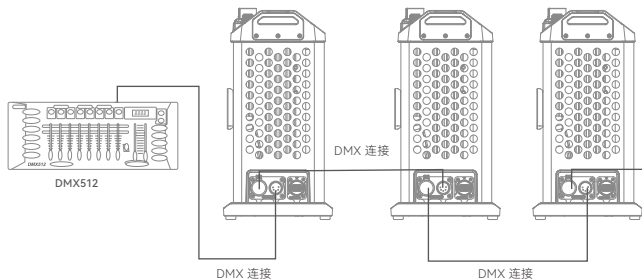

## 开关机

接通电源，短按控制器开关按键，实现开机或关机。

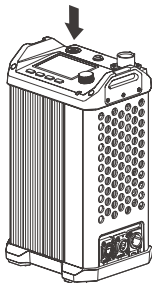

## CCT 模式

短按 MODE 按键进入模式选择界面，旋转调节旋钮可选 CCT 模式，短按调节旋钮进入 CCT 模式。

旋转调节旋钮可选亮度调节 / 色温调节 / 品红 - 绿调节，短按调节旋钮进入某项设置，左旋调节旋钮减少参数值，右旋调节旋钮增加参数值。

亮度: 0% ~100% (以 0.1%为增量)

色温: 1800K~10000K(以 100K 为增量)

品红 - 绿: -100% ~100% (以 1%为增量)

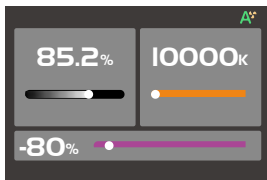

## HSI 模式

短按 MODE 按键进入模式选择界面，旋转调节旋钮可选 HSI 模式，短按调节旋钮进入 HSI 模式。

旋转调节旋钮可选亮度调节 / 色相调节 / 饱和度调节，短按调节旋钮进入某项设置，左旋调节旋钮减少参数值，右旋调节旋钮增加参数值。

亮度: 0% ~100% (以 0.1%为增量)

色相: 0° ~360° (以 1°为增量)

饱和度: 0% ~100% (以 1%为增量)



## RGBW 模式

短按 MODE 按键进入模式选择界面, 旋转调节旋钮可选 RGBW 模式, 短按调节旋钮进入 RGB 模式。旋转调节旋钮可选亮度调节 / 红光调节 / 绿光调节 / 蓝光调节 / 白光调节, 短按调节旋钮进入某项设置, 左旋调节旋钮减少参数值, 右旋调节旋钮增加参数值。

亮度: 0% ~100% (以 0.1%为增量)

红光: 0% ~100% (以 0.1%为增量)

绿光: 0% ~100% (以 0.1%为增量)

蓝光: 0% ~100% (以 0.1%为增量)

白光: 0% ~100% (以 0.1%为增量)

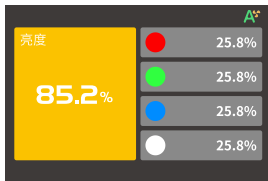

## GEL 模式

短按 MODE 按键进入模式选择界面, 旋转调节旋钮可选 GEL 模式, 短按调节旋钮进入 GEL 模式。旋转调节旋钮可选亮度调节 / 色片类型 / 色片组类型 / 颜色选择 / 色温 / 色相 / 饱和度, 短按调节旋钮进入某项设置, 左旋调节旋钮减少参数值, 右旋调节旋钮增加参数值。

亮度: 0% ~100% (以 0.1%为增量)

色片类型: R-GEL/L-GEL

色片组类型:

(R-GEL) COR./CAL./SPC./CINE.

(L-GEL) COR./COLOR./600/COS./700

色温: 3200K 或 5600K

色相:  $-10^{\circ}$  ~  $+10^{\circ}$  (以  $1^{\circ}$ 为增量)

饱和度:  $-20\%$  ~  $+20\%$  (以 1%为增量)



## X-Y 模式

短按 MODE 按键进入模式选择界面，旋转调节旋钮可选 X-Y 模式，短按调节旋钮进入 X-Y 模式。

旋转调节旋钮可选亮度调节 / X 坐标调节 / Y 坐标调节 / 颜色温度或颜色空间。短按调节旋钮进入某项设置，旋转调节旋钮调节参数。

亮度: 0% ~100% (以 0.1%为增量)

X 坐标: 0.0000~0.8000

Y 坐标: 0.0000~0.8000

颜色温度或颜色空间: Gamut, Rec.2020, DCI-P3, Rec.709, Black Body

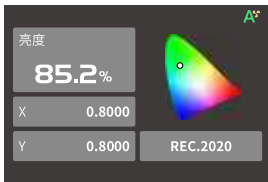

## FX 模式

短按 MODE 按键进入模式选择界面，旋转调节旋钮可选 FX 模式，短按调节旋钮进入 FX 模式。

旋转调节旋钮可选闪光灯 / 雷闪电 / 多云 / 坏灯泡 / 电视机 / 蜡烛 / 火 / 烟花 / 爆炸 / 焊接 / 警车 / SOS / 彩光循环 / 派对，短按调节旋钮进入某项设置。

### 1. 闪光灯

此光效模拟闪光灯闪光或传统镁光灯闪光，常用于营造一种生动、活泼的氛围。通过旋转调节旋钮选择某项设置，短按调节旋钮进入选项，根据需求旋转调节旋钮进行调节。

注：选中手动，通过短按一次调节旋钮触发一次闪光灯光效。

亮度: 0% ~100% (以 0.1%为增量)

开关: 开启 / 关闭

类型: CCT/HSI

色温 / 色相: 1800K-10000K/0-360°

触发: 手动 / 自动

速度: 1-100

模式: 闪光灯 / 镁光灯

### 2. 雷闪电

此光效模拟雷电的闪电，常用于营造一种紧张、恐怖或神秘的氛围。通过旋转调节旋钮选择某项设置，短按调节旋钮进入选项，根据需求旋转调节旋钮进行调节。

注：选中手动，通过短按一次调节旋钮触发一次雷闪电光效。

亮度: 0% ~100% (以 0.1%为增量)

开关: 开启 / 关闭

色温: 1800K-10000K

触发: 手动 / 自动

闪烁次数: 随机 / 1-10

频率: 随机 / 2-20

### 3. 多云

此光效模拟云层遮挡效果，常用于营造一种阴沉、压抑或悲伤氛围。通过旋转调节旋钮选择某项设置，短按调节旋钮进入选项，根据需求旋转调节旋钮进行调节。

亮度: 0% ~100% (以 0.1%为增量)

开关: 开启 / 关闭

亮暗比例: 30%-90%

速度: 随机 / 1-100

### 4. 坏灯泡

此光效模拟一盏损坏的灯泡闪光，常用于营造昏黄的环境氛围。通过旋转调节旋钮选择某项设置，短按调节旋钮进入选项，根据需求旋转调节旋钮进行调节。

亮度: 0% ~100% (以 0.1%为增量)

开关: 开启 / 关闭

类型: CCT/HSI

色温 / 色相: 1800K-10000K/0-360°

速度: 1-100

## 5. 电视机

此光效模拟电视机或屏幕的光线效果，常用于营造出一种冷淡、机械或数字化的氛围。通过旋转调节旋钮选择某项设置，短按调节旋钮进入选项，根据需求旋转调节旋钮进行调节。

亮度: 0% ~100% (以 0.1%为增量)

开关: 开启 / 关闭

类型: CCT/HSI

速度: 1-100

## 7. 火

此光效模拟火焰的光线效果，常用于营造出一种明亮、热烈、闪烁氛围。通过旋转调节旋钮选择某项设置，短按调节旋钮进入选项，根据需求旋转调节旋钮进行调节。

亮度: 0% ~100% (以 0.1%为增量)

开关: 开启 / 关闭

速度: 1-100

## 9. 爆炸

此光效模拟爆炸的光线效果，常用于营造出一种明亮、猛烈、闪烁氛围。通过旋转调节旋钮选择某项设置，短按调节旋钮进入选项，根据需求旋转调节旋钮进行调节。

注: 选中手动，通过短按一次调节旋钮触发一次爆炸光效。

亮度: 0% ~100% (以 0.1%为增量)

开关: 开启 / 关闭

颜色: CCT/HSI

色温 / 色相: 1800K-10000K/0-360°

触发: 手动 / 自动

余烬: 1-100

速度: 1-100

## 6. 蜡烛

此光效模拟蜡烛的光线效果，常用于营造出一种柔和、温暖、闪烁的氛围。通过旋转调节旋钮选择某项设置，短按调节旋钮进入选项，根据需求旋转调节旋钮进行调节。

亮度: 0% ~100% (以 0.1%为增量)

开关: 开启 / 关闭

速度: 1-100

## 8. 烟花

此光效模拟烟花的光线效果，常用于营造出一种绚丽、多彩、浪漫的氛围。通过旋转调节旋钮选择某项设置，短按调节旋钮进入选项，根据需求旋转调节旋钮进行调节。

亮度: 0% ~100% (以 0.1%为增量)

开关: 开启 / 关闭

速度: 1-100

余烬: 1-100

## 10. 焊接

此光效模拟焊接的光线效果，常用于营造出一种炽热、机械的氛围。通过旋转调节旋钮选择某项设置，短按调节旋钮进入选项，根据需求旋转调节旋钮进行调节。

亮度: 0% ~100% (以 0.1%为增量)

开关: 开启 / 关闭

类型: CCT/HSI

色温 / 色相: 1800K-10000K/0-360°

速度: 1-100

## 11. 警车



此光效模拟警车灯光的闪烁效果，常用于营造紧张、追逐或紧张氛围。通过旋转调节旋钮选择某项设置，短按调节旋钮进入选项，根据需求旋转调节旋钮进行调节。

亮度: 0% ~100% (以 0.1%为增量)

开关: 开启 / 关闭

颜色: 红 + 蓝、红、蓝、白 + 蓝、黄 + 蓝、黄、红 + 蓝 + 白、红 + 黄 + 蓝

模式: 1-5

## 13. 彩光循环



此光效模拟模拟彩色光线的循环和变化效果，常用于营造一种梦幻、科幻的氛围。通过旋转调节旋钮选择某项设置，短按调节旋钮进入选项，根据需求旋转调节旋钮进行调节。

亮度: 0% ~100% (以 0.1%为增量)

开关: 开启 / 关闭

饱和度: 0% ~100% (以 1%为增量)

速度: 1-100

## 12.SOS SOS

此光效模拟 SOS 求救信号的闪烁效果，常用于营造危险、求救或紧急情况氛围。通过旋转调节旋钮选择某项设置，短按调节旋钮进入选项，根据需求旋转调节旋钮进行调节。

亮度: 0% ~100% (以 0.1%为增量)

开关: 开启 / 关闭

类型: CCT/HSI

色温 / 色相: 1800K-10000K/0-360°

## 14. 派对



此光效模拟彩色光线、闪光灯和激光等效果，常用于营造一种狂欢、欢乐、高能氛围。通过旋转调节旋钮选择某项设置，短按调节旋钮进入选项，根据需求旋转调节旋钮进行调节。

亮度: 0% ~100% (以 0.1%为增量)

开关: 开启 / 关闭

饱和度: 0% ~100% (以 1%为增量)

速度: 1-100

## 菜单设置

短按 MENU 按键进入菜单设置，旋转调节旋钮选择 DMX、CRMX、蓝牙、以太网、Art-Net&sACN、调光曲线、控制模式、色域空间、风扇、屏幕设置、语言、版本与升级、恢复出厂设置、灯具信息。

MENU		
	DMX	001
	CRMX	开启
	蓝牙	开启
	以太网	关闭
	Art-Net & sACN	关闭
	调光曲线	线性
	控制模式	常规
	色域空间	原始
	风扇	高速
	屏幕设置	80%
	语言	中文
	版本与升级	V0.21
	恢复出厂设置	
	灯具信息	M600R

### 1.DMX

短按调节旋钮进入 DMX 设置界面。旋转调节旋钮选择地址 /DMX 模式 /RDM 状态 /DMX 丢失状态 / 终止开关 / 增强通道。短按调节旋钮进入选项设置，通过旋转调节旋钮完成选项设置。

DMX		
地址	510	
DMX模式	16:GEL 16bit	
RDM状态	关闭	
DMX丢失状态	保持最后状态	
终止开关	关闭	
增强通道	关闭	



一级选项	二级选项	说明
地址	001-512	起始地址
DMX模式	01: CCT 8 Bit	8位CCT模式
	02: HSI 8 Bit	8位HSI模式
	03: RGB 8 Bit	8位RGB模式
	04: RGBW 8 Bit	8位RGBW模式
	05: RGBWW 8 Bit	8位RGBWW模式
	06: CCT+HSI 8 Bit	8位CCT+HSI模式
	07: CCT+RGBW 8 Bit	8位CCT+RGBW模式
	08: FX 8 Bit	8位FX模式
	09: GEL 8 Bit	8位GEL模式
	10: CCT 16 Bit	16位CCT模式
	11: HSI 16 Bit	16位HSI模式
	12: RGB 16 Bit	16位RGB模式
	13: RGBW 16 Bit	16位RGBW模式
	14: X-Y 16 Bit	16位X-Y模式
	15: FX 16 Bit	16位FX模式
	16: GEL 16 Bit	16位GEL模式
RDM状态	开启	开启RDM, 开启后控制台可设置灯具地址及DMX模式
	关闭	关闭RDM
DMX丢失状态	保持最后状态	失去DMX控制信号后, 在关机或再次接收有效DMX控制信号前, 持续使用最后一次接收的DMX控制信号
	直接关闭	灯具直接熄灭
	保持最后状态2分钟熄灭	失去DMX控制信号后, 持续使用最后一次接收的DMX控制信号2分钟, 2分钟后灯具熄灭。注: 如2分钟内接收到有效DMX控制信号, 则使用新的DMX控制信号。
终止开关	开启	开启DMX终端
	关闭	关闭DMX终端
DMX增强通道	开启	开启增强通道信号
	关闭	关闭增强通道信号

注: 使用 DMX/RDM 控制台控制灯具, 可登录官网 <https://www.godox.com.cn/> 下载 DMX 实用表。

## 2. CRMX

短按调节旋钮进入 CRMX 设置界面。旋转调节旋钮选择 CRMX 开关 / 模式 / 发射功率 / 重置。短按调节旋钮进入某项设置。设置完毕，短按 MENU 按键返回上一级。

重置：短按调节旋钮进入重置界面，接着短按调节旋钮进行重置。

CRMX：开启 / 关闭

模式：发射模式 / 接收模式

发射功率：5dBm、11dBm、16dBm、20dBm、



## 3. 蓝牙

短按调节旋钮进入蓝牙设置界面。旋转调节旋钮选择蓝牙开关 / 蓝牙重置，短按调节旋钮进入某项设置。设置完毕，短按 MENU 按键返回上一级。

蓝牙开关：通过旋转调节旋钮完成设置。

蓝牙重置：旋转调节按钮选择确认，通过短按按钮完成设置。

蓝牙 MAC 码：位于界面左下角，方便查找灯具蓝牙。



## “GODOX Light”App 下载

描下面二维码即可下载“Godox Light”手机 app (安卓和苹果系统都可以使用)。

注：

1. 首个移动设备 (手机或平板电脑) 可直接使用 app 操控灯体。更换其他移动设备时，灯体需进行蓝牙重置方可正常使用 app。

2.App 需升级至 V3.0 以上版本。



#### 4. 以太网

短按调节旋钮进入以太网设置。进入界面后短按调节旋钮可设置网络模式，旋转调节旋钮可选 DHCP/Art-Net2.x/Art-Net 10.x/ 手动。设置完毕，短按 MENU 按键返回上一级。



一级选项	二级选项	说明
网络模式	DHCP	使用DHCP模式
	Art-Net 2.x	使用2.B.C.D网络
	Art-Net 10.x	使用10.B.C.D网络
	手动	可手动设置网络IP、子网掩码、默认网关
IP	AAA.BBB.CCC.DDD	如果启动DHCP模式，灯光ID地址则有DHCP分配。 如果启动Art-Net 2.x模式，灯光ID地址则为2.B.C.D。 如果Art-Net 10.x模式，灯光ID地址则为10.B.C.D。 如果启动手动模式，AAA=0-255 BBB=0-255 CCC=0-255 DDD=0-255
子网掩码	255.BBB.CCC.DDD	如果启动DHCP/Art-Net 2.x/Art-Net 10.x，子网掩码为255.BBB.CCC.DDD不能通过菜单更改。 如果启动手动，AAA=0-255 BBB=0-255 CCC=0-255 DDD=0-255
默认网关	AAA.BBB.CCC.DDD	如果启动DHCP模式，灯光默认网关则有DHCP分配。 如果启动Art-Net 2.x模式，灯光默认网关址则为2.B.C.D。 如果Art-Net 10.x模式，灯光默认网关则为10.B.C.D。 如果启动手动模式，AAA=0-255 BBB=0-255 CCC=0-255 DDD=0-255

## 5. Art-Net & sACN

短按调节旋钮进入 Art-Net&sACN 协议设置。

旋转调节旋钮可选 Art-Net&sACN/Art-Net Net/Art-Net Sub-Net/Art-Net Port/Art-Net Universe/sACN Universe, 短按调节旋钮进入某项设置。设置完毕, 短按 MENU 按键返回上一级。

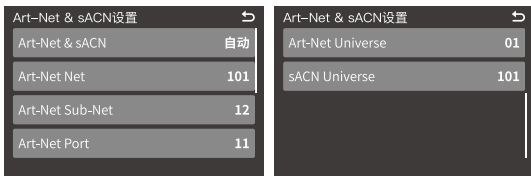

一级选项	二级选项	说明
Art-Net&sACN	自动/Art-Net/sACN/关	自动: 接受Art-Net&sACN两种协议。 Art-Net: 只接受Art-Net协议。 sACN: 只接受sACN协议。 关: 不接受网络协议。
Art-Net Net	0-127	选择Art-Net网络
Art-Net Sub-Net	0-15	在Art-Net网络中选择Art-Net子网
Art-Net Port	0-15	Art-Net端口
Art-Net Universe	0...32767	Art-Net域
sACN Universe	1...63999	sACN域

## 6. 调光曲线

短按调节旋钮进入调光曲线设置。旋转调节旋钮选择线性、S曲线、指数、对数。设置完毕, 短按调节旋钮 / 短按 MENU 按键返回上一级。



## 7. 控制模式

短按调节旋钮进入控制模式。短按调节旋钮选中模式，旋转调节旋钮选择对应模式，设置完毕，短按 MENU 按键返回上一级。

模式：常规

频率：1-10

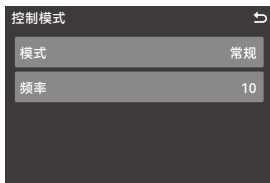

## 8. 色域空间

短按调节旋钮进入色域空间。短按调节旋钮选中色域空间，旋转调节旋钮选择对应色域，设置完毕，短按 MENU 按键返回上一级。

色域空间：原始色域、Rec.2020、DCI-P3、Rec.709。

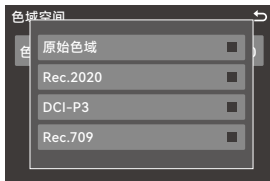

## 9. 风扇

短按调节旋钮进入风扇设置。旋转调节旋钮可选静音 / 自动 / 中速 / 高速。选择完毕，短按调节旋钮 / MENU 按键返回上一级。



## 10. 屏幕设置

短按调节旋钮进入屏幕设置。短按调节旋钮选中屏幕亮度，旋转调节旋钮调节参数，调节范围为 10% -100%。设置完毕，短按 MENU 按键返回上一级。



## 11. 语言

短按调节旋钮进入语言设置。旋转调节旋钮选择中文 /English, 短按调节旋钮完成设置。设置完毕, 短按 MENU 按键返回上一级。



## 12. 版本与升级

短按调节旋钮进入版本与升级设置, 在此界面可查看灯具固件版本及升级固件提示。查看完毕, 短按MENU按键返回上一级。

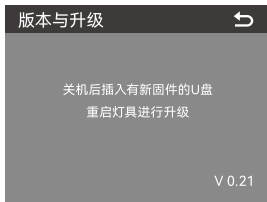

### 升级详情

1. 在官网 (<https://www.godox.com.cn/firmware-continuous-light>) 下载新固件到 U 盘上。
2. 在关机状态下, 将存有新固件的 U 盘插入 USB-A 接口。
3. 开机, 灯具自动进入升级界面。
4. 升级完毕自动跳回主界面。

注:

1. 必须在官网下载新固件, 存放在 U 盘根目录里, 而且仅有一个 BIN 文件。
2. USB-A 接口支持供电, 输出电压电流 5V/1.5A, 请勿接入大功率 USB 设备。

## 13. 恢复出厂设置

短按调节旋钮进入恢复出厂设置界面。旋转调节旋钮选择确定/取消, 短按调节旋钮完成设置。确认恢复出厂设置后, 灯体会重启, 界面自动出现简体中文和English选项, 旋转调节旋钮选择某项后短按调节旋钮完成设置, 此时灯体亮度值自动变为100%且界面来到色温模式。

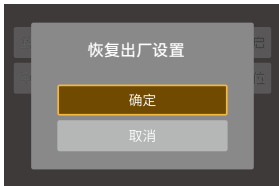

## 14. 灯具信息

短按调节旋钮进入灯具信息, 在此界面可查看灯具型号、UID 号、固件版本、灯头温度等信息。查看完毕, 短按 MENU 按键返回上一级。



## 锁定设置

短按 LOCK 按键, 屏幕出现 (🔒) 表示当前界面被锁定; 再次短按 LOCK 按键便可解锁。

注: 此锁定功能仅锁定控制器操控面板, 其他操作方式仍可正常操作。



## 预存设置

短按 PRESET 按键进入预存灯具光效界面。旋转调节旋钮选择 1-20 组预设, 短按调节旋钮进入预设组设置, 通过旋转调节旋钮可选应用 / 删除 / 保存 / 取消, 最后短按调节旋钮完成设置。设置完毕, 短按 PRESET 按键退出预存设置。

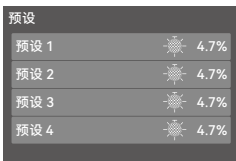

## 维护保养

一年保修期, 消耗品电池, 适配器, 电源线等配件不在此保修范围内。

经发现, 擅自检修此 LED 影视灯, 将取消 LED 影视灯一年保修期, 维修需要收取相关费用。

对于不规范操作引起的机器故障不在保修范围内。

所有维修一概由本厂指定的可供原配件的维修部负责。

如本品出现故障或者被水淋湿, 在专业人员维修后方可继续使用。LED 影视灯在工作时, 如发现异常, 应立即关掉电源, 查明原因。

## 照度数据

色温	测试条件	照度单位	3m	5m	7m
1800K	裸灯	lux	≈ 969	≈ 402	≈ 240
		fc	≈ 90	≈ 37	≈ 22
2800K		lux	≈ 2210	≈ 936	≈ 539
		fc	≈ 205	≈ 87	≈ 50
3200K		lux	≈ 2250	≈ 959	≈ 552
		fc	≈ 209	≈ 89	≈ 51
4300K		lux	≈ 2390	≈ 1010	≈ 577
		fc	≈ 222	≈ 94	≈ 54
5600K		lux	≈ 2560	≈ 1100	≈ 627
		fc	≈ 238	≈ 102	≈ 58
6500K	lux	≈ 2730	≈ 1150	≈ 663	
	fc	≈ 254	≈ 107	≈ 62	
8500K	lux	≈ 2700	≈ 1140	≈ 662	
	fc	≈ 251	≈ 106	≈ 62	
10000K	lux	≈ 2620	≈ 1100	≈ 632	
	fc	≈ 244	≈ 102	≈ 59	

色温	测试条件	照度单位	3m	5m	7m
1800K	带标配置 (45°)	lux	≈ 5130	≈ 1800	≈ 944
		fc	≈ 476	≈ 167	≈ 88
2800K		lux	≈ 10900	≈ 3850	≈ 2030
		fc	≈ 1010	≈ 358	≈ 188
3200K		lux	≈ 11200	≈ 3960	≈ 2090
		fc	≈ 1040	≈ 368	≈ 194
4300K		lux	≈ 11900	≈ 4190	≈ 2210
		fc	≈ 1100	≈ 389	≈ 206
5600K		lux	≈ 12900	≈ 4550	≈ 2400
		fc	≈ 1190	≈ 423	≈ 223
6500K	lux	≈ 13500	≈ 4790	≈ 2530	
	fc	≈ 1260	≈ 445	≈ 235	
8500K	lux	≈ 13600	≈ 4780	≈ 2520	
	fc	≈ 1260	≈ 444	≈ 235	
10000K	lux	≈ 13100	≈ 4600	≈ 2440	
	fc	≈ 1220	≈ 428	≈ 226	

数据均为平均值, 非绝对值, 以上测试皆在灯体 100%亮度下进行。

## 规格参数

型号	M600R
供电	100V-240V~50/60Hz
输入功率	720W
色温	1800K-10000K
品红 / 绿调节	-100% ~100%
调光范围	0%-100%
调光模式	线性 / S 曲线 / 指数 / 对数
CRI	平均≥ 96
TLCI	平均≥ 96
控制方式	DMX 512 控制台控制, 支持 RDM 协议 / LumenRadio CRMX 控制 / 以太网控制, 支持 Art-Net & sACN 协议 / 蓝牙 APP 控制 / 灯体控制
蓝牙控制距离	40 米
Type-A USB 接口	固件升级 / 5V=1.5A 供电
工作环境温度	-20°C ~45°C
尺寸(灯体包含 U 型支架)	灯体: 317mm*501mm*347mm/ 控制器: 189mm*166mm*334mm
净重≈	灯体 (包含 U 型支架和反光罩): 10kg 控制器: 6kg

设计和规格如有变更, 恕不另行通知。



## Important Safety Instructions and Precautions

First of all, as the most basic principle: This product is a professional lighting set equipment and should be used by professional lighting engineers or under the guidance of professionals. Basic safety precautions must always be followed during use, as follows:

1. The product manual must be read and understood before use.
2. Professional lighting is prohibited for children. When children are near, parents or accompanying persons must supervise closely to prevent children from personal injury due to collision with lamps or private use of lamps.
3. This lighting product is not ordinary lighting product and cannot be used for general lighting. Anyone who has suffered eye damage or has sensitive eyes should avoid using this product.
4. When the lamp is on, it must be used with care. Do not touch high-temperature parts, such as LED lamp beads, to avoid burns.
5. When the lamp is on, it is forbidden to look directly at the lamp beads under any circumstances. Strong light should be used under the guidance of professional lighting engineers. Avoid prolonged exposure to strong light under any circumstances. If eye discomfort, please turn off the lamp in time, suspend use, and seek medical attention in time.
6. If the lamp bead is damaged or deformed by heat, stop using it, and contact the manufacturer, service agent or qualified maintenance personnel to replace the lamp bead in time to avoid accidents.
7. This product is only suitable for use in  $-20^{\circ}\text{C}$  to  $45^{\circ}\text{C}$  working environment temperature and normal humidity environment.
8. Do not use damaged equipment or accessories, and wait for professional maintenance personnel to check and repair to confirm being normal before use.
9. During using, if the casing of this product is broken due to being dropped, squeezed or subjected to strong impact, please do not use it, so as to avoid electric shock injury due to contact with internal electronic components.
10. If an extension cord is required, please use an extension cord with a current rating greater than or equal to that of the equipment. If an extension cord is rated less than the equipment, overheating may result.
11. Some products have long power cords, please place the power cords properly and keep them in a safe place. Avoid contacting the power cord with hot surfaces, avoid misplacement that could cause pulling damage, or trip on-site personnel. Please use the certified power cord from the original manufacturer. If the product is damaged by using a non-certified power cord, it will not be repaired by our factory.
12. Be sure to unplug equipment from the power outlet before cleaning and repairing. When not in use, do not pull the power cord to unplug the equipment. For normal power-off, please hold both ends of the plug of the equipment with your hands and pull the plug out of power outlet. This equipment needs to be connected to a grounded outlet.
13. Do not disassemble the product without permission. If the product fails, it must be checked and repaired by authorized maintenance personnel.
14. Before storing, make sure that the equipment has cooled down completely. For storage, unplug the power cord from the equipment. The equipment should be placed in the carrying case or in a ventilated dry place.
15. Do not place equipment near flammable and volatile solvents such as alcohol and gasoline.
16. Do not use accessories that are not recommended by our factory to avoid fire, electric shock or personal injury.

17. When cleaning, do not wipe it with a damp cloth, please use a dry cloth or a soft cloth to wipe the dirt of the equipment.
18. Please take off the protective cover before using.
19. This product has passed ROHS, CE and FCC certification, please refer to the relevant national standards for use and operation.
20. The safety instructions are formulated according to the strict testing of the factory, and the design and specifications of the equipment are subject to change without prior notice. Customers can view the latest electronic instructions on the official website of GODOX and learn about the latest product information.
21. One-year warranty period, accessories such as consumable batteries, adapters, power cords, etc. are not covered by this warranty.
22. If it is found that the equipment is repaired without authorization, the one-year warranty period will be canceled and relevant fees will be charged for maintenance.
23. Machine failures caused by non-standard operation are not covered by the warranty.

**keep these instructions!**

## Foreword

Thank you for purchasing a Godox product.

The Godox M600R LED video light is a powerful lighting solution with a maximum output power of 700W. It features a full-color LED light source, allowing adjustable CCT and brightness to create the desired atmosphere according to different themes. The light beads are high-brightness and high-definition, supporting thousand-bit brightness adjustments. The separation of the light body and power adapter, along with its IP54 waterproof and dustproof rating and various wireless control options, make it suitable for both indoor and outdoor environments. The M600R is specifically designed to provide reliable lighting for small-scale advertising, microfilm shooting, outdoor recording, and other similar scenarios.

## Main Features

- 700W strong output power.
- Thousand-bit adjustable brightness from 0% to 100%.
- Wide CCT range adjustable from 1800-10000K.
- Super high CRI: CRI $\geq$ 96 TLCI $\geq$ 96
- Four dimming curves: linear, S-curve, exponential, logarithmic.
- Multiple control methods: control box, wired DMX, wireless DMX, Bluetooth, Ethernet.
- Both the lamp head and controller have IP54 protection rating, suitable for all-weather operation.
- Low lamp head temperature, excellent color stability, and long lifespan.
- 14 lighting modes available, fulfilling most basic special effect requirements.

## Warnings

- ⚠ Do not look directly at the LED light or illuminate at others' eyes.
- ⚠ Do not plug or unplug the power cable or connecting cable when the power is turned on, otherwise personal injuries may occur.
- ⚠ Do not cover the heat dissipation vent in working status.
- ⚠ Keep out of reach of children.
- ⚠ Please make sure to follow the instruction manual and correctly use this professional lighting device.



Don't stare at a bright light source

## Name of Parts

### Light Body

1. Handle
2. Direction Adjustment Handle
3. Lanyard Attachment
4. Yoke
5. Mount Locking Pusher
6. Bowens Mount
7. Quick Installation Device
8. ACC (Accessory Serial Port)
9. DC Input Port
10. 28mm Support Pole

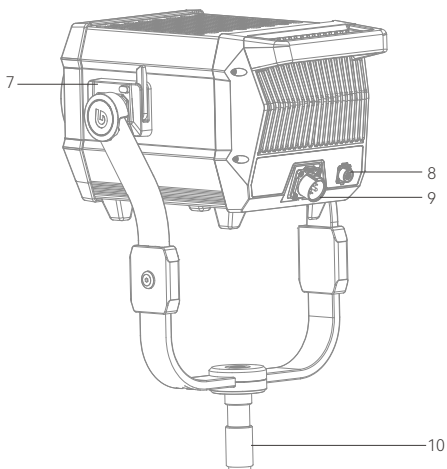
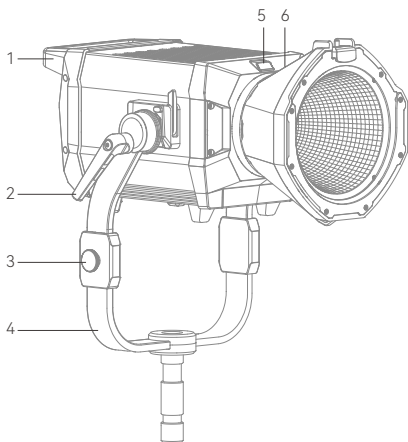

## Controller

- 1.Power Switch
- 2.Remove Controller Port
- 3.DC Output Port
- 4.Adjust Dial
5. LED Status Indicator
- 6.MODE Button
- 7.MENU Button
- 8.LOCK Button
- 9.PRESET Button
- 10.Display
- 11.DMX OUT Port
- 12.DMX IN Port
- 13.USB-A Port
- 14.AC Input Port
- 15.DC Input Port
- 16.LAN Port

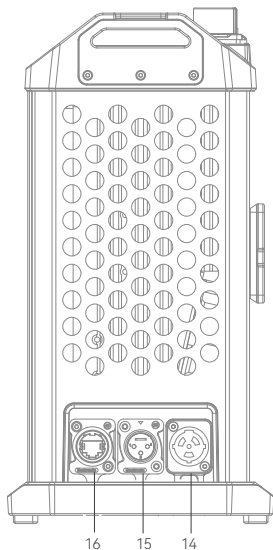
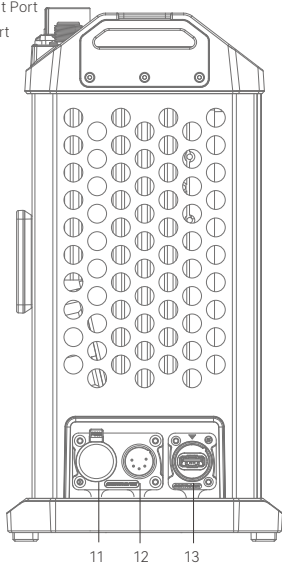
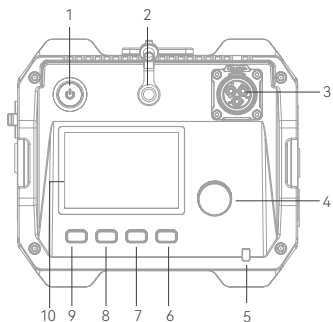

## What's Inside



Light Body x1

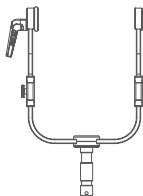

Yoke x1

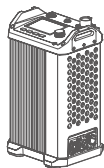

Controller x1

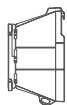

Reflector BR45 x1



Light Protection  
Cover x1



AC Power  
Cord x1



DC Cable x1



Tying Rope x1



Safety Wire x1



Pipe Clamp x1



Instruction Manual x1



Soft Case SC20 x1

Note: Due to continuous updates and upgrades of the products, there may be differences between the actual products and the pictures. Therefore, the pictures are for reference only, products to prevail in kind.

# Installation and Disassembly

## 1. Installing the Yoke

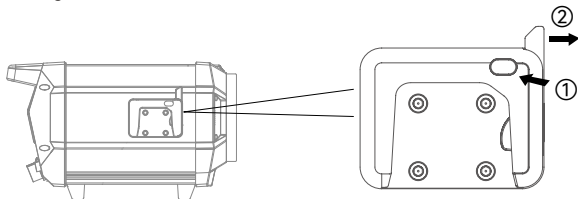

1.1 Place the light on a flat surface with the heat dissipation side facing up, the four legs of the light facing downwards, and the light-emitting surface facing towards you.

1.2 Hold down the quick installation device button on the light body and open the wrench.

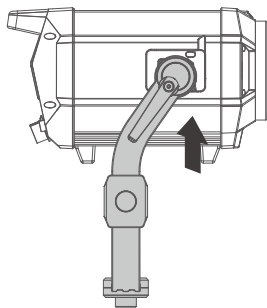

1.3 For installing the yoke, ensure that the direction adjustment handle is on the right side. Hold the yoke at both ends with both hands, align it with the quick installation device, and insert it from bottom to top. Then, tighten the wrenches on both sides. You will hear a "click" sound, indicating that the installation is complete.

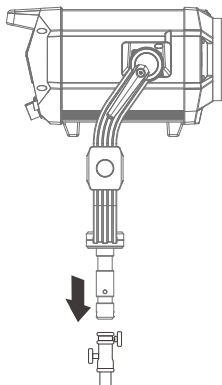

1.4 Install the light onto the roller stand and tighten the fixing knob of the roller stand.

Note: The roller stand is not included in the standard package and needs to be purchased separately.

⚠ Due to its large weight, please handle the installation with care to avoid personal injury.

## 2. Removing the Yoke

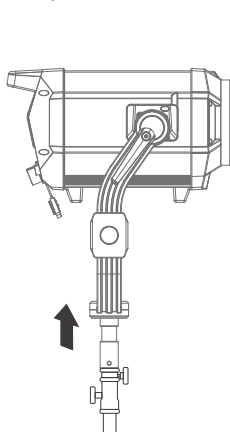

2.1 Hold the yoke of the light and remove it from the roller stand, placing it on a flat surface.

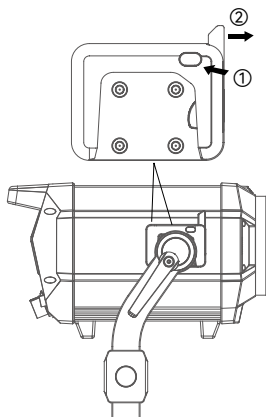

2.2 Press the quick installation device button and open the wrench to remove the yoke.

## 3. Installing/Removing the Light Protection Cover

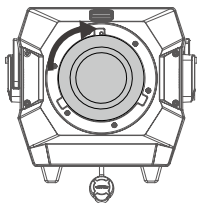

3.1 Align the light protection cover with the lamp head socket and rotate it clockwise to install it.

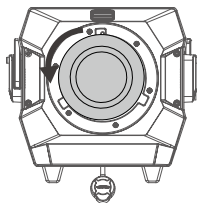

3.2 Press the mount locking pusher and rotate it counterclockwise to remove the light protection cover.



#### 4. Installing/Removing the Reflector

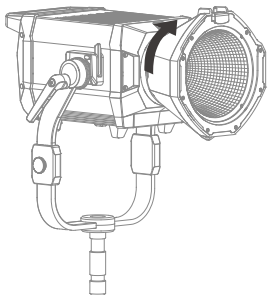

4.1 Align the reflector with the lamp head mount and insert it, then rotate it clockwise to install it securely.

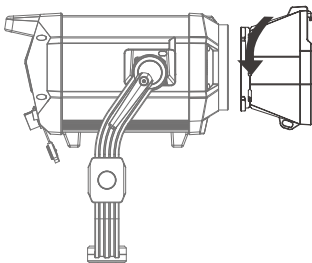

4.2 Hold the mount locking pusher and rotate it counterclockwise to remove the reflector.

Note: Please ensure proper alignment when inserting into the mount.

#### 5. Mounting the Controller to the Light Stand

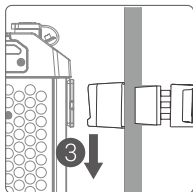
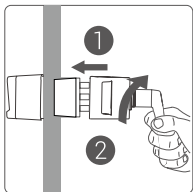

5.1 Loosen the handle of the pipe clamp, insert it into the light stand pole, and rotate the handle clockwise to lock the pipe clamp securely. Finally, align the controller's quick installation device with the slot on the pipe clamp and insert it.

## 6.Connect to DMX Controller

### 6.1 Wireless DMX Connection

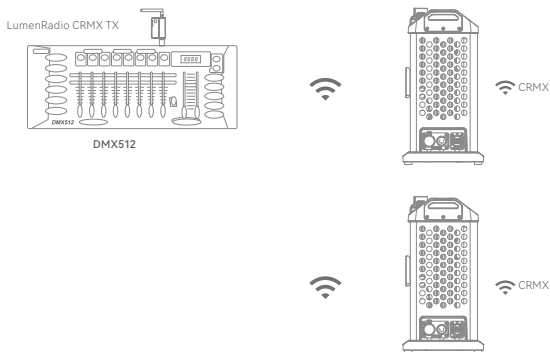

### 6.2 Wired DMX Connection

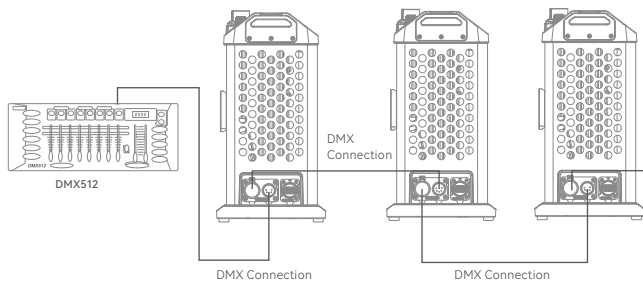

## Power Switch

To power on or power off the device, simply press and hold the controller's power button.

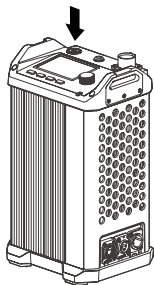

## CCT Mode

Briefly press the MODE button to switch to CCT mode. Briefly rotate the adjust dial to select CCT mode and press it to enter CCT mode interface.

Rotate the select dial to adjust brightness/CCT/magenta-green adjustment. Press the adjust dial briefly to enter a specific setting. Rotate the dial counterclockwise to decrease the parameter value and clockwise to increase the parameter value.

Brightness: 0%~100% (in increments of 0.1%)

CCT: 1800K~10000K (in increments of 100K)

Magenta-green: -100%~100% (in increments of 1%)

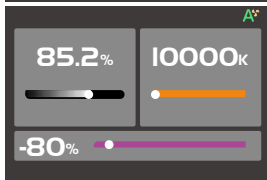

## HSI Mode

Press the MODE button briefly to enter the mode selection interface. Rotate the adjust dial to select the HSI Mode, and press the select dial briefly to enter the HSI Mode.

Rotating the adjust dial allows you to adjust brightness/hue/saturation. Press the adjust dial briefly to enter a specific setting. Turn the dial counterclockwise to decrease the parameter value and clockwise to increase the parameter value.

Brightness: 0%~100% (in increments of 0.1%)

Hue: 0°~360° (in increments of 1°)

Saturation: 0%~100% (in increments of 1%)

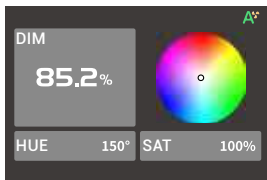

## RGBW Mode

Press the MODE button briefly to enter the mode selection interface. Rotate the adjust dial to select RGBW, and press the adjust dial briefly to enter the RGBW Mode.

Rotating the adjust dial allows you to adjust brightness/red/green/blue/white color. Press the adjust dial briefly to enter a specific setting. Turn the dial counterclockwise to decrease the parameter value and clockwise to increase the parameter value.

Brightness: 0%~100% (in increments of 0.1%)

Red: 0%~100% (in increments of 0.1%)

Green: 0%~100% (in increments of 0.1%)

Blue: 0%~100% (in increments of 0.1%)

White: 0%~100% (in increments of 0.1%)

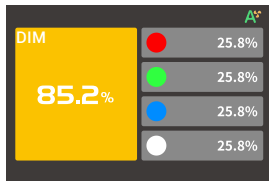

## GEL Mode

Press the MODE button briefly to enter the mode selection interface. Rotate the adjust dial to select the GEL Mode, and press the adjust dial briefly to enter the GEL Mode.

Rotating the adjust dial allows you to adjust brightness/gel type/gel group type/color selection/CCT/hue/saturation. Press the adjust dial briefly to enter a specific setting. Turn the dial counterclockwise to decrease the parameter value and clockwise to increase the parameter value.

Brightness: 0%~100% (in increments of 0.1%)

Gel Type: R-GEL/L-GEL

Gel Group Type: (R-GEL) COR./CAL./SPC./CINE.  
(L-GEL) COR./COLOR./600/COS./700

Color Temperature: 3200K or 5600K

Hue: -10°~+10° (in increments of 1°)

Saturation: -20%~+20% (in increments of 1%)

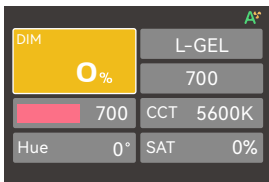

## X-Y Mode

Press the MODE button briefly to enter the mode selection interface. Rotate the adjust dial to select the X-Y Mode, and press the adjust dial briefly to enter the X-Y Mode.

Rotating the adjust dial allows you to adjust brightness/X-coordinate/Y-coordinate/color temperature or color space. Press the adjust dial briefly to enter a specific setting and then rotate the adjust dial to adjust the parameter.  
Brightness: 0%~100% (in increments of 0.1%)  
X-coordinate: 0.0000~0.8000  
Y-coordinate: 0.0000~0.8000  
Color Temperature or Color Space: Gamut, REC.2020, DCI-P3, Rec.709, Black Body

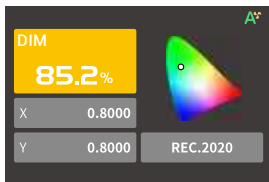

## FX Mode

Press the MODE button briefly to enter the mode selection interface. Rotate the adjust dial to select the FX Mode, and press the adjust dial briefly to enter the FX Mode.

Rotating the adjust dial allows you to select from the following light effects: flash/ lightning/ cloudy/broken bulb/TV/candle/firework/explosion/welding/police car/SOS/RGB cycle/party. Press the adjust dial briefly to enter a specific setting.

### 1. Flash

This light effect simulates the flash of a strobe light or a traditional magnesium light, often used to create a lively and dynamic atmosphere.

Rotate the adjust dial to select a specific setting. Press the adjust dial briefly to select an option and then adjust the parameter by rotating the dial as needed.

Brightness: 0%~100% (in increments of 0.1%)

On/Off: Turn the light on or off

Type: CCT/HSI

CCT/Hue: 1800K-10000K/0-360°

Trigger: Manual/Auto

Speed: 1-100

Mode: Flash/Magnesium Light

Note: If you select Manual mode, press the select dial briefly once to trigger the flash light effect.

## 2. Lightning

This light effect simulates the lightning of thunder, often used to create a tense, terrifying, or mysterious atmosphere.

Rotate the adjust dial to select a specific setting. Press the adjust dial briefly to select an option and then adjust the parameter by rotating the dial as needed.

Brightness: 0%~100% (in increments of 0.1%)

On/Off: Turn the light on or off

CCT: 1800K-10000K

Trigger: Manual/Auto

Flashes: Random/1-10

Frequency: Random/2-20

Note: If you select Manual mode, press the adjust dial briefly once to trigger the lightning effect.

## 3. Cloudy

This light effect simulates the obstructive effect of clouds and is often used to create a gloomy, oppressive, or sad atmosphere.

Rotate the adjust dial to select a specific setting. Press the adjust dial briefly to select an option and then adjust the parameter by rotating the dial as needed.

Brightness: 0%~100% (in increments of 0.1%)

On/Off: Turn the light on or off

Brightness Ratio: 30%-90%

Speed: Random/1-100

## 4. Broken Bulb

This light effect simulates a flash from a broken bulb and is often used to create a dim, yellowish atmosphere.

Rotate the adjust dial to select a specific setting. Press the adjust dial briefly to select an option and then adjust the parameter by rotating the dial as needed.

Brightness: 0%~100% (in increments of 0.1%)

On/Off: Turn the light on or off

Type: CCT/HSI

CCT/Hue: 1800K-10000K/0-360°

Speed: 1-100

## 5. TV

This light effect simulates the lighting effect of a TV or screen and is often used to create a cold, mechanical, or digitized atmosphere.

Rotate the adjust dial to select a specific setting. Press the adjust dial briefly to select an option and then adjust the parameter by rotating the dial as needed.

Brightness: 0%~100% (in increments of 0.1%)

On/Off: Turn the light on or off

Type: CCT/HSI

Speed: 1-100

## 6. Candle

This light effect simulates the lighting effect of a candle and is often used to create a soft, warm, and flickering atmosphere.

Rotate the adjust dial to select a specific setting. Press the adjust dial briefly to select an option and then adjust the parameter by rotating the dial as needed.

Brightness: 0%~100% (in increments of 0.1%)

On/Off: Turn the light on or off

Speed: 1-100

## 7. Fire

This light effect simulates the lighting effect of a flame and is often used to create a bright, warm, and flickering atmosphere.

Rotate the adjust dial to select a specific setting. Press the adjust dial briefly to select an option and then adjust the parameter by rotating the dial as needed.

Brightness: 0%~100% (in increments of 0.1%)

On/Off: Turn the light on or off

Speed: 1-100

## 8. Firework

This light effect simulates the lighting effect of firework and is often used to create a colorful, romantic, and dazzling atmosphere.

Rotate the adjust dial to select a specific setting. Press the adjust dial briefly to enter an option and then adjust the parameter by rotating the dial as needed.

Brightness: 0%~100% (in increments of 0.1%)

On/Off: Turn the light on or off

Speed: 1-100

Embers: 1-100

## 9. Explosion

This light effect simulates the lighting effect of an explosion and is often used to create a bright, intense, and flickering atmosphere.

Rotate the adjust dial to select a specific setting. Press the adjust dial briefly to select an option and then adjust the parameter by rotating the dial as needed.

Brightness: 0%~100% (in increments of 0.1%)

On/Off: Turn the light on or off

Color: CCT/HSI

CCT/Hue: 1800K-10000K/0-360°

Trigger: Manual/Auto

Embers: 1-100

Speed: 1-100

Note: To activate the explosion light effect when set to manual mode, press the select dial once briefly.

## 10. Welding

This light effect simulates the lighting effect of welding and is often used to create a hot and mechanical atmosphere.

Rotate the adjust dial to select a specific setting. Press the adjust dial briefly to select an option and then adjust the parameter by rotating the dial as needed.

Brightness: 0%~100% (in increments of 0.1%)

On/Off: Turn the light on or off

Type: CCT/HSI

CCT/Hue: 1800K-10000K/0-360°

Speed: 1-100



## 11. Police Car



This lighting effect simulates the flashing lights of a police car and is commonly used to create a tense, chasing, or suspenseful atmosphere.

Rotate the adjust dial to select a specific setting. Press the adjust dial briefly to select an option and then adjust the parameter by rotating the dial as needed.

Brightness: 0% to 100% (in increments of 0.1%)

On/Off: Turn the light on or off

Colors: Red+Blue, Red, Blue, White+Blue, Yellow+Blue, Yellow, Red+Blue+White, Red+Yellow+Blue

Modes: 1-5

## 12. SOS SOS

This lighting effect simulates the flashing of an SOS distress signal and is commonly used to create a dangerous, distressing, or emergency atmosphere.

Rotate the adjust dial to select a specific setting. Press the adjust dial briefly to select an option and then adjust the parameter by rotating the dial as needed.

Brightness: 0% to 100% (in increments of 0.1%)

On/Off: Turn the light on or off

Type: CCT/HSI

Color Temperature/Hue: 1800K-10000K/0-360°

## 13. RGB Cycle



This lighting effect simulates the cycle and variation of colored light effects, and is commonly used to create a dreamy, sci-fi atmosphere.

Rotate the adjust dial to select a specific setting. Press the adjust dial briefly to select an option and then adjust the parameter by rotating the dial as needed.

Brightness: 0% to 100% (in increments of 0.1%)

On/Off: Turn the light on or off

Saturation: 0% to 100% (in increments of 1%)

Speed: 1-100

## 14. Party



This lighting effect simulates the effects of colorful lights, flash lights, and lasers, and is commonly used to create a festive, joyful, high-energy atmosphere.

Rotate the adjust dial to select a specific setting. Press the adjust dial briefly to select an option and then adjust the parameter by rotating the dial as needed.

Brightness: 0% to 100% (in increments of 0.1%)

On/Off: Turn the light on or off

Saturation: 0% to 100% (in increments of 1%)

Speed: 1-100

## Menu Settings

Press the MENU button briefly to enter the menu settings. Rotate the adjust dial to choose from DMX, CRMX, Bluetooth, Network Settings, Art-Net & sACN, Dimming Curve, Control Mode, Color Space, Fan, Display, Language, Version & Upgrade, Factory Reset, and Fixture Info.

	DMX	512
	CRMX	On
	Bluetooth	On
	Network Settings	Auto
	Art-Net & sACN	Auto
	Dimming Curves	Linear
	Control Mode	Normal
	Color Space	Original Gamut
	Fan	ON
	Display	80%
	Language	English
	Version & Upgrade	V0.21
	Factory Reset	002
	Fixture Info	M600R

## 1. DMX

Press the adjust dial briefly to enter the DMX settings interface. Rotate the dial to choose from Address/DMX Mode/RDM State/DMX Lost / Termination /Extended DMX Channel. Press the dial briefly to enter the option settings, and adjust the settings by rotating the dial as needed.

DMX	
Address	510
DMX Mode	16:GEL 16bit
RDX State	Off
DMX Lost	Hold Last Command
Termination	Off
Extend DMX Channels	Off

Level 1 Option	Level 2 Option	Description
Address	001-512	Initial Address
DMX Mode	01:CCT 8 Bit	CCT 8 bit
	02:HSI 8 Bit	HSI 8 bit
	03:RGB 8 Bit	RGB 8 bit
	04: RGBW 8 Bit	RGBW 8 bit
	05: RGBWW 8 Bit	RGBWW 8 bit
	06: CCT+HSI 8 Bit	CCT+HSI 8 bit
	07:CCT+RGBW 8 Bit	CCT+RGBW8 bit
	08: FX 8 Bit	FX 8 bit
	09:GEL 8 Bit	GEL 8 bit
	10:CCT 16 Bit	CCT 16 bit
	11:HSI 16 Bit	HSI 16 bit
	12:RGB 16 Bit	RGB 16 bit
	13:RGBW 16 Bit	RGBW 16 bit
	14:X-Y 16 Bit	X-Y 16 bit
	15:FX 16 Bit	FX 16 bit
	16:GEL 16 Bit	GEL 16 bit
RDM State	On	Turn on RDM, the ADD and DMX mode can be set by controller.
	Off	Turn off RDM
DMX Lost	Hold Last Command	After the DMX control signal is lost, continue to use the last received DMX control signal until power down or a valid DMX control signal is received again.
	Black Out	The light is off immediately.
	Black Out After 2 Min.	After the DMX control signal is lost, continue to use the last received DMX control signal for 2 minutes then black out. Note: If a valid DMX control signal is received within 2 minutes, then use the new DMX control signal.
Termination	On	Turn on DMX terminal
	Off	Turn off DMX terminal
Extend DMX Channels	On	Turn on extend DMX channels
	Off	Turn off extend DMX channels

Note: Please refer to the "M600R DMX Practical Table" to control the device by DMX/RDM. The electronic version can be downloaded from the official website <https://www.godox.com>.

## 2. CRMX

Press the adjust dial briefly to enter the CRMX settings interface. Rotate the dial to choose from CRMX On/Off, Mode, Transmit Power, and Reset. Press the dial briefly to enter a specific setting. Once the settings are complete, press the MENU button briefly to return to the previous level.

Reset: Press the adjust dial briefly to enter the reset interface, then press the dial briefly to reset.

CRMX: On/Off

Mode: Transmit/Receive Mode

Transmit Power: 5dbm, 11dbm, 16dbm, 20dbm

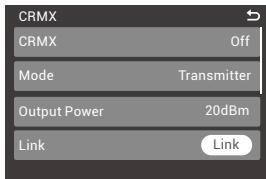

## 3. Bluetooth

Press the adjust dial briefly to enter the Bluetooth settings interface. Rotate the dial to choose from Bluetooth On/Off and Bluetooth Reset, then press the dial briefly to enter a specific setting. Once the settings are complete, press the MENU button briefly to return to the previous level.

Bluetooth On/Off: Adjust the setting by rotating the adjust dial.

Bluetooth Reset: Press the dial briefly, then press it again to confirm the reset.

Bluetooth MAC Address: Located in the lower left corner of the interface, making it easy to find the Bluetooth of the fixture.

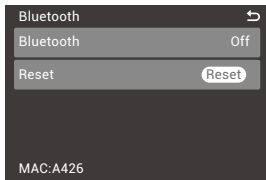

## Download "GODOX Light" App

Scan the QR code to download the "Godox Light" smartphone App (can be used in Android and iOS).

Note:

1.The App can be used directly on the firstly installed device (smartphone or laptop). When change to other mobile device (smartphone or iPad), the light shall be reset before the normal connection of the app.

2.The app version should be 3.0 or above.



## 4. Network Settings

Press the adjust dial briefly to enter network settings interface. Press the adjust dial briefly to select network mode, then rotate to select among DHCP, Art-Net 2.x, Art-Net 10.x and manual. Finally, press the MENU button briefly to return to the previous menu.

Network Settings	
Network Mode	Manual
IP	192 172 6 103
Subnet Mask	255 255 255 0
Gateway	192 168 1 1
MAC: 0c:cc:47:d3:00:00	

Level 1 Option	Level 2 Option	Description
Network Mode	DHCP	DHCP mode
	Art-Net2.x	To use 2.B.C.D network
	Art-Net 10.x	To use 10.B.C.D network
	Manual	Set the network IP, subnet mask, and default gateway manually
IP	AAA.BBB.CCC.DDD	The ID address is assigned by DHCP in DHCP mode. The ID address is 2.B.C.D in Art-Net 2.x mode. The ID address is 10.B.C.D in Art-Net 10.x mode. In manual mode: AAA = 0-255 BBB = 0-255 CCC = 0-255 DDD = 0-255
Subnet Mask	255.BBB.CCC.DDD	The subnet mask is 255.BBB.CCC.DDD and can not be adjusted by menu settings in DHCP/Art-Net 2.x/Art-Net 10.x mode. In manual mode: AAA = 0-255 BBB = 0-255 CCC = 0-255 DDD = 0-255
Gateway	AAA.BBB.CCC.DDD	The gateway is assigned by DHCP in DHCP mode. The gateway is 2.B.C.D in Art-Net 2.x mode. The gateway is 10.B.C.D in Art-Net 10.x mode. In manual mode: AAA = 0-255 BBB = 0-255 CCC = 0-255 DDD = 0-255

## 5. Art-Net & sACN

Press the adjust dial briefly to enter Art-Net & sACN setting interface. Rotate the adjust dial to select options among Art-Net&sACN, Art-Net Net, Art-Net Sub-Net, Art-Net Port, Art-Net Universe and sACN Universe, then press the adjust dial briefly to enter a specific setting. Once the settings are complete, press the MENU button briefly to return to the previous menu.

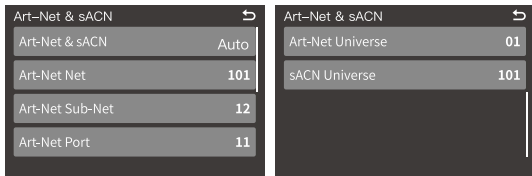

Level 1 Option	Level 2 Option	Description
Art-Net&sACN	Auto/Art-Net/sACN/Off	Auto: Art-Net & sACN two protocols are accepted. Art-Net: Only Art-Net protocol. sACN: Only sACN protocol. Off: No network protocols are accepted.
Art-Net Net	0-127	Art-Net network
Art-Net Sub-Net	0-15	Choose Art-Net subnet in Art-Net network.
Art-Net Port	0-15	Art-Net port
Art-Net Universe	0...32767	Art-Net universe
sACN Universe	1...63999	sACN universe

## 6. Dimming Curves

Press the adjust dial briefly to enter dimming curves setting interface. Rotate and press the adjust dial briefly to choose among linear, S-curve, exponential and logarithmic. Once the settings are complete, press the MENU button briefly to return to the previous menu.

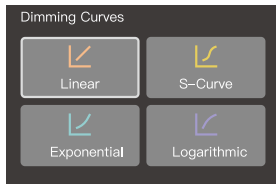

## 7. Control Mode

Press the adjust dial briefly to enter the control mode. Press the adjust dial briefly select the mode, rotate the adjust dial to choose the corresponding mode. Once the settings are complete, press the MENU button briefly to return to the previous menu.

Modes: Normal

Frequency: 1-10.

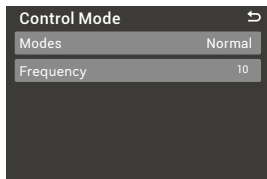

## 8. Color Space

Press the adjust dial briefly to enter the color space. Press the adjust dial briefly select the color space, rotate the adjust dial to choose the corresponding color space. Once the settings are complete, press the MENU button briefly to return to the previous menu.

Color Space: Original Gamut, Rec.2020, DCI-P3, and Rec. 709.

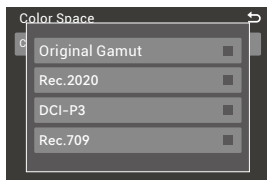

## 9. Fan

Press the adjust dial briefly to enter fan setting interface. Rotate the adjust dial briefly to choose among silent, auto, medium speed and high speed. Once the settings are complete, press the MENU button briefly to return to the previous menu.

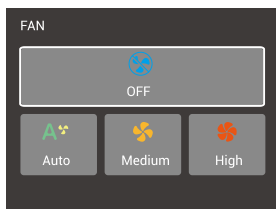

## 10. Display

Press the adjust dial to enter display setting interface. Rotate and press the adjust dial briefly to adjust display brightness from 10% to 100%. Once the settings are complete, press the MENU button briefly to return to the previous menu.

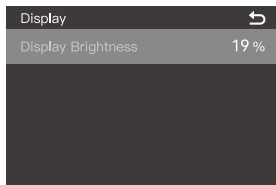

## 11. Language

Press the adjust dial to enter language setting interface. Rotate and press the adjust dial briefly to select between Chinese and English. Once the settings are complete, press the MENU button briefly to return to the previous menu.



## 12. Version & Upgrade

Press the adjust dial to enter version & upgrade setting interface to check the firmware version and upgrade instructions. Then, press the MENU button briefly to return to the previous menu.



### Software Upgrade

1. Download the new firmware to the U disk from official website (<https://www.godox.com.cn/firmware-continuous-light>).
2. Turn off the device. Insert the U disk with new firmware into the USB Type-A port.
3. Turn on the device, and it will automatically enter the upgrading interface.
4. It will return to the main interface upon completion.

#### Notes:

1. New firmware must be downloaded from the official website, and keep only one BIN file in the root directory of the USB disk.
2. The USB Type-A port can only support output voltage and current of 5V/1.5A. Do not connect to over-rated USB device.



### 13. Factory Reset

Press the adjust dial briefly to enter factory reset setting interface. Rotate and press the adjust dial briefly to select yes or no, then press the adjust dial to confirm the selection. Once the factory reset is confirmed, the light will restart, and the interface will automatically display options for Simplified Chinese and English. Rotate the adjust dial to select a desired option, then press the dial to confirm the selection. At this point, the brightness value will automatically be set to 100%, and the interface will switch to the CCT mode.

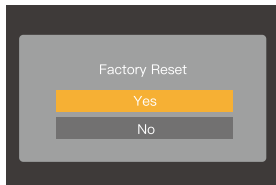

### 14. Fixture Info

Press the adjust dial briefly to enter fixture info setting interface to check model, UID NO., firmware version, light head temp., etc. Then, press the MENU button briefly to return to the previous menu.

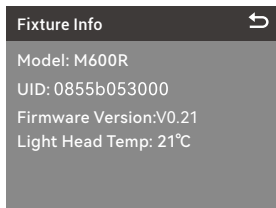

### Lock Setting



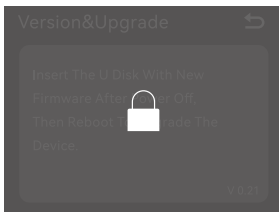

Press the LOCK button briefly, the panel will be locked when <img alt="locked padlock icon" data-bbox="195 685 220 705"/> is displayed on the panel, press the button briefly again to unlock the panel.

Note: The locking function only works on the controller panel, other operations are still available.



## Preset Setting

Press the PRESET button briefly to enter preset effects interface. Rotate and press the adjust dial briefly to choose and enter preset effects 1-20, then press briefly to choose apply/delete/save/cancel. Once the settings are complete, press the adjust dial briefly to return to the previous menu and press the PRESET button briefly to exit.

Preset		
Preset 1		4.7%
Preset 2		4.7%
Preset 3		4.7%
Preset 4		4.7%

## Maintenance

This product, except consumables, is supported with a one-year warranty.

Unauthorized service will void the warranty.

Maintenance of the light must be performed by our authorized maintenance department which can provide original accessories.

If the product had failures or got wet, do not use it until it is repaired by professionals.

Shut down the device immediately should abnormal operation be detected.

## Photometric Data

CCT	Test Condition	Unit	3m	5m	7m
1800K	Bare Light	lux	≈ 969	≈ 402	≈ 240
		fc	≈ 90	≈ 37	≈ 22
2800K		lux	≈ 2210	≈ 936	≈ 539
		fc	≈ 205	≈ 87	≈ 50
3200K		lux	≈ 2250	≈ 959	≈ 552
		fc	≈ 209	≈ 89	≈ 51
4300K		lux	≈ 2390	≈ 1010	≈ 577
		fc	≈ 222	≈ 94	≈ 54
5600K		lux	≈ 2560	≈ 1100	≈ 627
		fc	≈ 238	≈ 102	≈ 58
6500K	lux	≈ 2730	≈ 1150	≈ 663	
	fc	≈ 254	≈ 107	≈ 62	
8500K	lux	≈ 2700	≈ 1140	≈ 662	
	fc	≈ 251	≈ 106	≈ 62	
10000K	lux	≈ 2620	≈ 1100	≈ 632	
	fc	≈ 244	≈ 102	≈ 59	

CCT	Test Condition	Unit	3m	5m	7m
1800K	With Reflector (45°)	lux	≈ 5130	≈ 1800	≈ 944
		fc	≈ 476	≈ 167	≈ 88
2800K		lux	≈ 10900	≈ 3850	≈ 2030
		fc	≈ 1010	≈ 358	≈ 188
3200K		lux	≈ 11200	≈ 3960	≈ 2090
		fc	≈ 1040	≈ 368	≈ 194
4300K		lux	≈ 11900	≈ 4190	≈ 2210
		fc	≈ 1100	≈ 389	≈ 206
5600K		lux	≈ 12900	≈ 4550	≈ 2400
		fc	≈ 1190	≈ 423	≈ 223
6500K	lux	≈ 13500	≈ 4790	≈ 2530	
	fc	≈ 1260	≈ 445	≈ 235	
8500K	lux	≈ 13600	≈ 4780	≈ 2520	
	fc	≈ 1260	≈ 444	≈ 235	
10000K	lux	≈ 13100	≈ 4600	≈ 2440	
	fc	≈ 1220	≈ 428	≈ 226	

All the above tests are based on the condition of 100% brightness.

## Technical Data

Model	M600R
Power Supply	100V-240V~50/60Hz
Input Power	≈720W
CCT	1800-10000K
GM Adjustment	-100%~100%
Brightness Range	0% -100%
Dimming Curves	linear, S-curve, exponential, logarithmic
CRI	Average≥96
TLCI	Average≥96
Controlling Methods	DMX 512 Control(support RDM protocol)/Lumen Radio CRMX/Ethernet (support Art-Net & sACN protocol)/ Bluetooth Control/Light Body Control
Bluetooth Controlling Distance	Max. 40m
USB Type-A Port	Firmware Upgrade/5V===1.5A Power Supply
Working Environment Temperature	-20°C ~45°C
Dimension(Yoke included)	Light Body: 12.48" × 19.72" × 13.66" Controller: 7.44" × 6.54" × 13.15"
Netweight≈	Light Body(Including yoke and reflector): 10kg Controller: 6kg

Specifications and data may subject to changes without notice.

## FCC Statement

This device complies with part 15 of the FCC Rules. Operation is subject to the following two conditions:

- (1) This device may not cause harmful interference, and
- (2) this device must accept any interference received, including interference that may cause undesired operation.

Any Changes or modifications not expressly approved by the party responsible for compliance could void the user's authority to operate the equipment.

Note: This equipment has been tested and found to comply with the limits for a Class B digital device, pursuant to part 15 of the FCC Rules. These limits are designed to provide reasonable protection against harmful interference in a residential installation. This equipment generates uses and can radiate radio frequency energy and, if not installed and used in accordance with the instructions, may cause harmful interference to radio communications. However, there is no guarantee that interference will not occur in a particular installation. If this equipment does cause harmful interference to radio or television reception, which can be determined by turning the equipment off and on, the user is encouraged to try to correct the interference by one or more of the following measures:

- Reorient or relocate the receiving antenna.
- Increase the separation between the equipment and receiver.
- Connect the equipment into an outlet on a circuit different from that to which the receiver is connected.
- Consult the dealer or an experienced radio/TV technician for help.

The device has been evaluated to meet general RF exposure requirement.  
The device can be used in portable exposure condition without restriction.

## Warning

Operating frequency:2402MHz – 2480MHz (BT/CRMX)  
Maximum EIRP Power: 9.36dBm(BT) / 7.91dBm(CRMX)

### Declaration of Conformity

GODOX Photo Equipment Co.,Ltd. hereby declares that this equipment are in compliance with the essential requirements and other relevant provisions of Directive 2014/53/EU. In accordance with Article 10(2) and Article 10(10), this product is allowed to be used in all EU member states.For more information of DoC, Please click this web link:

<https://www.godox.com/eu-declaration-of-conformity/>

The device complies with RF specifications when the device used at 0mm from your body.

## 产品保修

尊敬的用户，本保修卡是申请保修服务的重要凭证，请您配合销售商填写并妥善保管，谢谢！

产品信息	型号	产品条码
用户信息	姓名	联系电话
	通信地址	
销售商信息	名称	
	联系电话	
	通信地址	
	销售日期	
备注		

注：此表应由销售商盖章确认。

### 产品信息

本文件适用于相关《产品保修信息》(见后面说明)所列产品,其他非属此范围的产品或部件(如促销品、赠品及其他出厂后附加的部件等)不在此保修承诺内。

### 保修期

产品及部件的相应保修期按相关的《产品保修信息》执行。保修期自产品首次购买日起算，购买日以购买产品时保修卡登记日期为准。

### 如何获得保修服务

您可直接与产品销售商或授权服务机构联系，也可拨打神牛产品售后服务电话，与我们联系，由我们的服务人员为您安排服务。申请保修时，您应提供有效的保修卡作为保修凭证，方可获得保修。如您不能提供有效的保修卡，则在我们确认产品或部件属于保修范围的情况下，也可以为您提供保修，但这不作为我们的义务。

## 不适用保修情况

如产品存在下列情况，本文件项下的保证和服务将不适用：①产品或部件超过相应保修期；②错误或不当使用、维护或保管导致的故障或损坏，如：不当搬运；非按产品合理预期用途使用；不当插拔外接设备；跌落或外力挤压；接触或暴露于不当温度、溶剂、酸碱、水浸或潮湿环境；③由非神牛授权机构或人员安装、修理、更改、添加或拆卸造成的故障或损坏；④产品或部件原有识别信息被修改变更或删除；⑤无有效保修卡；⑥使用非合法授权、非标准或非公开发行的软件造成的故障或损坏；⑦因不可抗力或意外事件造成的故障或损坏；⑧其他非因产品本身质量问题导致的故障或损坏。遇上述情况，您应向相关责任方寻求解决，神牛对此不承担任何责任。因非在保修期或保修范围内的部件、附件或软件导致产品不能正常使用的，不是保修范围内的故障。产品使用过程中正常的脱色，磨损和消耗，不是保修范围内的故障。

## 产品保修和服务支持信息

产品的保修期和服务类型按以下《产品保修信息》执行：

产品类别	选件名称	保修期(月)	保修服务类型
部件	电路板	12	客户送修
	电池	3	客户送修
	充电器等带电性能的部件。	12	客户送修
其他	如外壳、保护罩、锁紧装置、包装等。	无	无保修

神牛产品售后服务电话 0755-29609320-8062

## Warranty

Dear customers, as this warranty card is an important certificate to apply for our maintenance service, please fill in the following form in coordination with the seller and safe-keep it. Thank you!

Product Information	Model	Product Code Number
Customer Information	Name	Contact Number
	Address	
Seller Information	Name	
	Contact Number	
	Address	
	Date of Sale	
Note		

Note: This form shall be sealed by the seller.

### Applicable Products

Applicable Products The document applies to the products listed on the Product Maintenance Information (see below for further information). Other products or accessories (e.g. promotional items, giveaways and additional accessories attached, etc.) are not included in this warranty scope.

### Warranty Period

The warranty period of products and accessories is implemented according to the relevant Product Maintenance Information. The warranty period is calculated from the day (purchase date) when the product is bought for the first time, and the purchase date is considered as the date registered on the warranty card when buying the product.

### How to Get the Maintenance Service

If maintenance service is needed, you can directly contact the product distributor or authorized service institutions. You can also contact the Godox after-sale service call and we will offer you service. When applying for maintenance service, you should provide valid warranty card. If you cannot provide valid warranty card, we may offer you maintenance service once confirmed that the product or accessory is involved in the maintenance scope, but that shall not be considered as our obligation.

## Inapplicable Cases

The guarantee and service offered by this document are not applicable in the following cases:

① The product or accessory has expired its warranty period; ② Breakage or damage caused by inappropriate usage, maintenance or preservation, such as improper packing, improper usage, improper plugging in/out external equipment, falling off or squeezing by external force, contacting or exposing to the improper temperature, solvent, acid, base, flooding and damp environments, etc; ③ Breakage or damage caused by non-authorized institution or staff in the process of installation, maintenance, alternation, addition and detachment; ④ The original identifying information of product or accessory is modified, alternated, or removed; ⑤ No valid warranty card; ⑥ Breakage or damage caused by using illegally authorized, nonstandard or non-public released software; ⑦ Breakage or damage caused by force majeure or accident; ⑧ Breakage or damage that could not be attributed to the product itself. Once met these situations above, you should seek solutions from the related responsible parties and Godox assumes no responsibility. The damage caused by parts, accessories and software that beyond the warranty period or scope is not included in our maintenance scope. The normal discoloration, abrasion and consumption are not the breakage within the maintenance scope.

## Maintenance and Service Support Information

The warranty period and service types of products are implemented according to the following Product Maintenance Information:

Product Type	Name	Maintenance Period(month)	Warranty Service Type
Parts	Circuit board	12	Customer sends the product to designated site
	Battery	3	Customer sends the product to designated site
	Electrical parts e.g.battery charger, etc.	12	Customer sends the product to designated site
Other Items	Lamp body, lamp cover, locking device, package, etc.	No	Without warranty

Godox After-sale Service Call +86-755-29609320(8062)





Wechat  
Official Account  
神牛微信公众号

### 深圳市神牛摄影器材有限公司

地址：深圳市宝安区福海街道塘尾社区耀川工业园厂房 2 栋  
电话：0755-29609320 (8062) 传真：0755-25723423 邮箱：godox@godox.com

### GODOX Photo Equipment Co., Ltd.

Add.: Building 2, Yaochuan Industrial Zone, Tangwei Community, Fuhai Street, Bao'an District, Shenzhen  
518103, China Tel: +86-755-29609320(8062) Fax: +86-755-25723423 E-mail: godox@godox.com

[www.godox.com](http://www.godox.com)

Made in China | 705-M600R0-06

